

2022

FİYAT LİSTESİ
PRICE LIST



HAKKIMIZDA ABOUT US

1975 yılında Hasan TAMER tarafından Ankara'da elektrik dağıtım tesisatında kullanılan sac ürünleri imalatı ile iş hayatına başlamıştır. 1980 yılına kadar süren sac imalatı sonrası, halen sürmekte olan elektrik sarf malzemelerinin toptan ve perakende satışını sürdürmüştür.

1996 yılında Ostim 'de imalat çalışmalarına başlanmış ve bugün Sarayköy-Kahramankazan'da 8200 m² kapalı alanında üretimlerine devam etmektedir. Yapısında seçkin kadrosuyla 1996 yılından günümüze üretimde çeşitliliğe gidilmiş, bu kapsamda 2000 yılında ISO 9001 Kalite Yönetim Sistemi belgesini bünyesine kazandırmıştır. Akabinde 2007 de ISO 14001 Çevre Yönetim Sistemi belgesini, 2014 te ISO 45001 İş Sağlığı ve Güvenliği Yönetim Sistemi belgesi, RoHS belgeleri, TSE ürün belgeleri, CE belgeleri ve ürünler ile ilgili uluslararası test belgeleri bulundurmaktadır.

Ürün gamında; Alçak ve Orta gerilim sınıfı dahilinde; reçineli, ısı büzüşmeli kablo ek muflarını, reçineli, ısı büzüşmeli ve silikon kablo başlıklarını, sıkmalı kablo pabuçları, sıkmalı ek mufları, Protolin ve ProSil yalıtım sıvılarını, AG&OG Buşing ve VHD kapama, havai hat izolasyon kapama malzemelerini üretmektedir. 2011 yılı başı ile Türkiye'de bir ilk olan "Isı Büzüşmeli Boru" üretimine geçerek bir ilki gerçekleştirmiş ve Türkiye için ufak, kendi için büyük bir yeniliğe imza atmıştır.

2018 yılında TAMGRUP ışınlama tesisini faaliyete alarak, Türkiye'de elektron hızlandırıcı (e-beam) tesisi kurarak yerli üretimde ki gücünü ve yerli üretime olan katkısını artırmıştır. Yalıtım alanında, kablo eklerinde, kablo başlıklarında ve aksesuarları üretiminde kaliteden taviz vermeden, müşteri memnuniyetinin üst seviyede tutulması ilkesine olan bağlılığını sürdürmeye devam edecektir.



The company was founded by Hasan TAMER in Ankara in 1975 for the manufacturing of metal sheet products used in electricity distribution networks. After the manufacturing of metal sheets which continued until the year 1980, the company has started dealing with the wholesale and retail marketing of the electricity products which is still continuing today.

The manufacturing works were started in 1996 in Ostim and now it is continuing in Sarayköy-Kahramankazan within a closed area of 8200 m². The variety of the range of products has been given utmost care by the expert staff from the year 1996 and in this respect; ISO 9001 Quality certificate was received by the company and pursuant to this ISO 9001 Environmental Management System certificate was received in 2007, ISO 45001 occupational health and safety management system certification received in 2014 and the company also has RoHS documents, all TSE Product certificates, CE certificates, international test report for products.

The product range of the company is composed of; Low and medium voltage class, resin, heat shrinkable cable joints and resin, heat shrinkable and silicon terminations, compressive cable lugs, compressive cable connectors, Protolin and Prosil insulation fluids, LV & MV Bushing and VHD covering, overhead-line protection. By the beginning of the year 2011, the company started the manufacturing of "heat shrinkable tubes" which was an innovation and has taken a small step for Turkey but a large step for itself. The irradiation facility TAMGRUP taking activities. In 2018, the power of the electron accelerator by establishing local production facilities in Turkey and increased its contribution to domestic production.

The company will always fulfill its principle of keeping the customer satisfaction at utmost level without ignoring the quality in the sector of insulation and in manufacturing of the cable end sleeves and accessories.





Hayata Bağlar...
Connects to Life



TAMER

varsa

o Őehirde hayat var...





TAM GRUP

Enerji İnşaat Işınlama
San.Tic.Ltd.Şti.

www.tamgrup.com.tr

2011 yılında kurulmuş olan şirketimiz, enerji, inşaat ve ışınlama alanlarında hizmet vermek, yapısında ileri teknolojik cihaz, ekipman desteği ile müşterilerine güvenilir ve hızlı bir şekilde hizmet vermek amacıyla kurulmuştur.

Bünyesinde 3MeV'lik elektron hızlandırıcı ile ürünler üzerinde de çapraz bağlama yaparak hizmet vermektedir.

Ürünlerin kalitesini artırmak, yarı mamulleri tam mamul olarak hizmete geçirmek amaçlı kullanılmaktadır.

1. Polimer Malzemeler
2. Kablo Sanayi
3. Otomotiv Sanayi
4. Lastik Sanayi
5. Ağaç ve Plastik Endüstrisi
6. Ahşap + Plastik Kompozit Malzeme
7. Motor Sanayi
8. Savunma Sanayi

**TÜRKİYE'NİN
İLK 3MeV ELEKTRON
HIZLANDIRICI
TESİSİ**

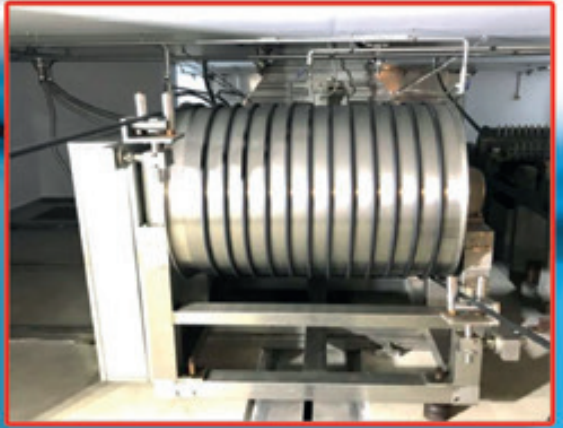

Avantajları nelerdir?

- Ürünlerin fiziki dayanımı artmakta.
- Malzeme ömrünü uzatır.
- Malzemelere form verilebilmektedir.
- Hızlı servis ile zamandan tasarruf
- Ekonomik maliyet.
- Ürün kalitesinde artış sağlama.



t/e TAMER
ELEKTRİK



**AG & OG
SIKMALI & MEKANİK
BAĞLAYICILAR**



Reçineli Ek Mufları

08 →

Protolinler

24 →

İzolasyon Kapamalar

28 →

Isı Büzüşmeli Ek Muflar

30 →

AG Kablo Başlıkları

50 →

OG Isı Büzüşmeli Kablo Başlıkları

60 →

Silikon Kablo Başlıkları

76 →

SKP & SEM

82 →

Isı Büzüşmeli Borular

88 →

Aksesuarlar

94 →

KOD CODE	KABLO KESİTİ CROSS SECTION	ADET/KOLİ UNIT/BOX	FİYAT PRICE
E1 4105 - E1 4205	4 x 1,5 - 4 x 2,5	60	168,00 ₺
E1 404 - E1 406	4 x 4 - 4 x 6	60	168,00 ₺
E1 515 - E1 525	5 x 1,5 - 5 x 2,5	60	185,00 ₺
E1 504 - E1 506	5 x 4 - 5 x 6	60	185,00 ₺
E1 715 - E1 725	7 x 1,5 - 7 x 2,5	60	286,00 ₺

0.6-1 kV



KOD CODE	KABLO KESİTİ CROSS SECTION	ADET/KOLİ UNIT/BOX	FİYAT PRICE
E1 215 - E1 204	2 x 1,5 - 2 x 4	60	156,00 ₺
E1 206	2 x 6	60	156,00 ₺
E1 210	2 x 10	27	249,00 ₺
E1 216 - E1 225	2 x 16 - 2 x 25	27	249,00 ₺
E1 235 - E1 250	2 x 35 - 2 x 50	27	273,00 ₺
E1 270 - E1 295	2 x 70 - 2 x 95	18	374,00 ₺
E1 2120 - E1 2150	2 x 120 - 2 x 150	12	664,00 ₺
E1 2185	2 x 185	4	693,00 ₺
E1 2240	2 x 240	4	753,00 ₺

0.6-1 kV



KOD CODE	KABLO KESİTİ CROSS SECTION	ADET/KOLİ UNIT/BOX	FİYAT PRICE
E1 115 - E1 104	1 x 1,5 - 1 x 4	60	152,00 ₺
E1 106	1 x 6	60	152,00 ₺
E1 110	1 x 10	60	180,00 ₺
E1 116- 125	1 x 16 - 1 x 25	60	180,00 ₺
E1 135 -E1 150	1 x 35 - 1 x 50	60	195,00 ₺
E1 170 - E1 195	1 x 70 - 1 x 95	60	208,00 ₺
E1 1120 - E1 1150	1 x 120 - 1 x 150	40	278,00 ₺
E1 1185	1 x 185	40	347,00 ₺
E1 1240	1 x 240	40	358,00 ₺
E1 1300	1 x 300	24	464,00 ₺
E1 1400	1 x 400	24	486,00 ₺
E1 1500	1 x 500	24	524,00 ₺

0.6-1 kV

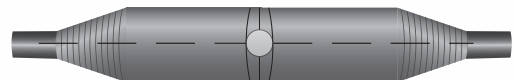

* İstenilen Kablo Kesitlerine Göre Ek Yapılır. / * Produce Joint According To Demand

BAKIR İLETKENLER İÇİN REÇİNELİ KABLO EK MUFLARI

FOR COPPER CONNECTORS RESIN CABLE JOINT

KOD CODE	KABLO KESİTİ CROSS SECTION	ADET/KOLİ UNIT/BOX	FİYAT PRICE
E1 410	4 x 10	27	260,00 ₺
E1 416	4 x 16	27	265,00 ₺
E1 31610	3 x 16 + 10	27	265,00 ₺
E1 32516	3 x 25 + 16	27	277,00 ₺
E1 33516	3 x 35 + 16	27	291,00 ₺
E1 35025	3 x 50 + 25	27	303,00 ₺
E1 425	4 x 25	27	283,00 ₺
E1 435	4 x 35	27	297,00 ₺
E1 450	4 x 50	27	308,00 ₺
E1 510 - E1 516	5 x 10 - 5 x 16	27	277,00 ₺

0.6-1 kV



KOD CODE	KABLO KESİTİ CROSS SECTION	ADET/KOLİ UNIT/BOX	FİYAT PRICE
E1 315 - E1 304	3 x 1,5 - 3 x 4	60	162,00 ₺
E1 306	3 x 6	60	162,00 ₺
E1 310	3 x 10	27	250,00 ₺
E1 316	3 x 16	27	257,00 ₺
E1 325	3 x 25	27	263,00 ₺
E1 335	3 x 35	27	277,00 ₺
E1 350	3 x 50	27	286,00 ₺

0.6-1 kV

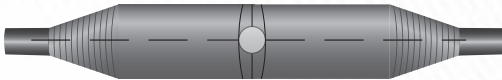

KOD CODE	KABLO KESİTİ CROSS SECTION	ADET/KOLİ UNIT/BOX	FİYAT PRICE
E1 37035	3 x 70 + 35	24	485,00 ₺
E1 39550	3 x 95 + 50	24	509,00 ₺
E1 470	4 x 70	24	459,00 ₺
E1 495	4 x 95	24	520,00 ₺
E1 525	5 x 25	24	487,00 ₺
E1 535	5 x 35	24	495,00 ₺
E1 550	5 x 50	24	509,00 ₺

0.6-1 kV



KOD CODE	KABLO KESİTİ CROSS SECTION	ADET/KOLİ UNIT/BOX	FİYAT PRICE
E1 370	3 x 70	18	479,00 ₺
E1 395	3 x 95	18	502,00 ₺

0.6-1 kV



KOD CODE	KABLO KESİTİ CROSS SECTION	ADET/KOLİ UNIT/BOX	FİYAT PRICE
E1 31207	3 x 120 + 70	10	809,00 ₺
E1 31507	3 x 150 + 70	10	845,00 ₺
E1 4120	4 x 120	10	842,00 ₺
E1 4150	4 x 150	10	878,00 ₺
E1 570	5 x 70	10	813,00 ₺
E1 595	5 x 95	10	847,00 ₺

0.6-1 kV

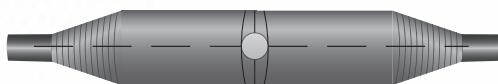

BAKIR İLETKENLER İÇİN REÇİNELİ KABLO EK MUFLARI

FOR COPPER CONNECTORS RESIN CABLE JOINT

Reçineli
Ek Muflar

KOD CODE	KABLO KESİTİ CROSS SECTION	ADET/KOLİ UNIT/BOX	FİYAT PRICE
E1 3120	3 x 120	10	800,00 ₺
E1 3150	3 x 150	10	835,00 ₺

0.6-1 kV



KOD CODE	KABLO KESİTİ CROSS SECTION	ADET/KOLİ UNIT/BOX	FİYAT PRICE
E1 31859	3 x 185 + 95	4	1.248,00 ₺
E1 32401	3 x 240 + 120	4	1.340,00 ₺
E1 4185	4 x 185	4	1.282,00 ₺
E1 4240	4 x 240	4	1.370,00 ₺
E1 5120	5 x 120	4	1.253,00 ₺
E1 5150	5 x 150	4	1.291,00 ₺

0.6-1 kV

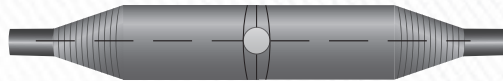

KOD CODE	KABLO KESİTİ CROSS SECTION	ADET/KOLİ UNIT/BOX	FİYAT PRICE
E1 3185	3 x 185	4	1.240,00 ₺
E1 3240	3 x 240	4	1.333,00 ₺

0.6-1 kV





0.6-1 kV



0.6-1 kV

KOD CODE	KABLO KESİTİ CROSS SECTION	ADET/KOLİ UNIT/BOX	FİYAT PRICE
AE1 4105 - AE1 4205	4 x 1,5 - 4 x 2,5	60	161,00 ₺
AE1 404 - AE1 406	4 x 4 - 4 x 6	60	161,00 ₺
AE1 515 - AE1 525	5 x 1,5 - 5 x 2,5	60	180,00 ₺
AE1 504 - AE1 506	5 x 4 - 5 x 6	60	161,00 ₺
AE1 715 - AE1 725	7 x 1,5 - 7 x 2,5	60	278,00 ₺

KOD CODE	KABLO KESİTİ CROSS SECTION	ADET/KOLİ UNIT/BOX	FİYAT PRICE
AE1 215 - AE1 204	2 x 1,5 - 2 x 4	60	150,00 ₺
AE1 206	2 x 6	60	150,00 ₺
AE1 210	2 x 10	27	243,00 ₺
AE1 216 - AE1 225	2 x 16 - 2 x 25	27	249,00 ₺
AE1 235 - AE1 250	2 x 35 - 2 x 50	27	269,00 ₺
AE1 270 - AE1 295	2 x 70 - 2 x 95	18	369,00 ₺
AE1 2120 - AE1 2150	2 x 120 - 2 x 150	12	660,00 ₺
AE1 2185	2 x 185	4	689,00 ₺
AE1 2240	2 x 240	4	748,00 ₺

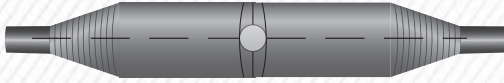

0.6-1 kV



0.6-1 kV

KOD CODE	KABLO KESİTİ CROSS SECTION	ADET/KOLİ UNIT/BOX	FİYAT PRICE
AE1 410	4 x 10	27	255,00 ₺
AE1 416	4 x 16	27	262,00 ₺
AE1 31610	3 x 16 + 10	27	259,00 ₺
AE1 510 - E1 516	5 x 10 - 5 x 16	27	268,00 ₺

KOD CODE	KABLO KESİTİ CROSS SECTION	ADET/KOLİ UNIT/BOX	FİYAT PRICE
AE1 115 - AE1 104	1 x 1,5 - 1 x 4	60	148,00 ₺
AE1 106	1 x 6	60	148,00 ₺
AE1 110	1 x 10	60	176,00 ₺
AE1 116-125	1 x 16 - 1 x 25	60	176,00 ₺
AE1 135 -AE1 150	1 x 35 - 1 x 50	60	204,00 ₺
AE1 170 - AE1 195	1 x 70 - 1 x 95	60	204,00 ₺
AE1 1120 - AE1 1150	1 x 120 - 1 x 150	40	272,00 ₺
AE1 1185	1 x 185	40	342,00 ₺
AE1 1240	1 x 240	40	355,00 ₺
AE1 1300	1 x 300	24	457,00 ₺
AE1 1400	1 x 400	24	470,00 ₺
AE1 1500	1 x 500	24	516,00 ₺

ALÜMİNYUM İLETKENLER İÇİN REÇİNELİ KABLO EK MUFLARI

FOR ALUMINUM CONNECTORS RESIN CABLE JOINT



0.6-1 kV



0.6-1 kV

KOD CODE	KABLO KESİTİ CROSS SECTION	ADET/KOLİ UNIT/BOX	FİYAT PRICE
AE1 32516	3x25+16	27	271,00 ₺
AE1 33516	3x35+16	27	286,00 ₺
AE1 35025	3x50+25	27	297,00 ₺
AE1 425	4x25	27	280,00 ₺
AE1 435	4x35	27	296,00 ₺
AE1 450	4x50	27	303,00 ₺

KOD CODE	KABLO KESİTİ CROSS SECTION	ADET/KOLİ UNIT/BOX	FİYAT PRICE
AE1 325	3x25	27	259,00 ₺
AE1 335	3x35	27	271,00 ₺
AE1 350	3x50	27	280,00 ₺

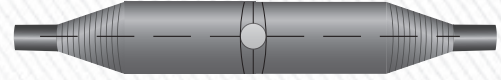

0.6-1 kV



0.6-1 kV

KOD CODE	KABLO KESİTİ CROSS SECTION	ADET/KOLİ UNIT/BOX	FİYAT PRICE
AE1 525	5x25	18	435,00 ₺
AE1 535	5x35	18	439,00 ₺
AE1 550	5x50	18	450,00 ₺

KOD CODE	KABLO KESİTİ CROSS SECTION	ADET/KOLİ UNIT/BOX	FİYAT PRICE
AE1 370	3x70	18	468,00 ₺
AE1 395	3x95	18	480,00 ₺

KOD CODE	KABLO KESİTİ CROSS SECTION	ADET/KOLİ UNIT/BOX	FİYAT PRICE
AE1 37035	3x70+35	18	565,00 ₺
AE1 39550	3x95+50	18	587,00 ₺
AE1 31207	3x120+70	10	800,00 ₺
AE1 31507	3x150+70	10	840,00 ₺
AE1 470	4x70	18	706,00 ₺
AE1 495	4x95	18	742,00 ₺
AE1 4120	4x120	10	835,00 ₺
AE1 4150	4x150	10	873,00 ₺
AE1 570	5x70	10	808,00 ₺
AE1 595	5x95	10	842,00 ₺

0.6-1 kV

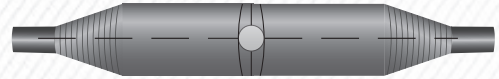

KOD CODE	KABLO KESİTİ CROSS SECTION	ADET/KOLİ UNIT/BOX	FİYAT PRICE
AE1 3120	3x120	10	785,00 ₺
AE1 3150	3x150	10	830,00 ₺

0.6-1 kV



KOD CODE	KABLO KESİTİ CROSS SECTION	ADET/KOLİ UNIT/BOX	FİYAT PRICE
AE1 31859	3x185+95	4	1.237,00 ₺
AE1 32401	3x240+120	4	1.300,00 ₺
AE1 4185	4x185	4	1.275,00 ₺
AE1 4240	4x240	4	1.335,00 ₺
AE1 5120	5x120	4	1.250,00 ₺
AE1 5150	5x150	4	1.285,00 ₺

0.6-1 kV



KOD CODE	KABLO KESİTİ CROSS SECTION	ADET/KOLİ UNIT/BOX	FİYAT PRICE
AE1 3185	3x185	4	1.230,00 ₺
AE1 3240	3x240	4	1.287,00 ₺

0.6-1 kV



REÇİNELİ KABLO EK MUFLARI

*Güç yalıtımlı bağlantılarda,
yer altı, yer üstü enerji kabloları,
ve telefon bağlantısında
güvenilir çözüm*



KOD CODE	KABLO KESİTİ CROSS SECTION	KOLİ ADETİ UNIT / BOX	FİYAT PRICE
ŞE1 410	4x10	40	255,00 ₺
ŞE1 416	4x16	40	255,00 ₺
ŞE1 425	4x25	40	267,00 ₺
ŞE1 31610	3x16 +10	40	255,00 ₺
ŞE1 32516	3x25 +16	40	260,00 ₺
ŞE1 1015 - ŞE1 1025	10x1,5 - 10x2,5	40	318,00 ₺
ŞE1 1004 - ŞE1 1006	10x4 - 10x6	40	318,00 ₺

0.6-1 kV



KOD CODE	KABLO KESİTİ CROSS SECTION	KOLİ ADETİ UNIT / BOX	FİYAT PRICE
ŞE1 435	4x35	20	616,00 ₺
ŞE1 450	4x50	20	616,00 ₺
ŞE1 470	4x70	20	637,00 ₺
ŞE1 495	4x95	20	653,00 ₺
ŞE1 33516	3x35+16	20	608,00 ₺
ŞE1 35025	3x50+25	20	620,00 ₺
ŞE1 37035	3x70+35	20	664,00 ₺
ŞE1 39550	3x95+50	20	630,00 ₺
ŞE1 2415 - ŞE1 2425	24x1,5 - 24x2,5	20	643,00 ₺

0.6-1 kV



KOD CODE	KABLO KESİTİ CROSS SECTION	Y. ÇIKIŞ KESİTİ BRANCH SECTION	FİYAT PRICE
YE1 11015	1x10	1x1,5	217,00 ₺
YE1 11615	1x16	1x1,5	217,00 ₺
YE1 12516	1x25	1x16	232,00 ₺
YE1 13525	1x35	1x25	232,00 ₺
YE1 15035	1x50	1x35	267,00 ₺
YE1 17050	1x70	1x50	267,00 ₺
YE1 19570	1x95	1x70	313,00 ₺
YE1 112095	1x120	1x95	313,00 ₺
YE1 41515	4x1,5	4x1,5	346,00 ₺
YE1 42515	4x2,5	4x1,5	346,00 ₺
YE1 44015	4x4	4x1,5	346,00 ₺
YE1 41015	4x10	4x1,5	346,00 ₺

0.6-1 kV



ŞEFFAF REÇİNELİ KABLO EK MUFLARI

TRANSPARENT RESIN CABLE JOINTS

KOD CODE	KABLO KESİTİ CROSS SECTION	KOLİ ADETİ UNIT / BOX	FİYAT PRICE
TE1 410	4x10	10	695,00 ₺
TE1 416	4x16	10	695,00 ₺
TE1 425	4x25	10	727,00 ₺
TE1 31610	3x16+10	10	695,00 ₺
TE1 32516	3x25+16	10	727,00 ₺
TE1 516	5x16	10	742,00 ₺



T Tip
T Type No:1

KOD CODE	KABLO KESİTİ CROSS SECTION	KOLİ ADETİ UNIT / BOX	FİYAT PRICE
TE1 435	4x35	10	1.105,00 ₺
TE1 450	4x50	10	1.115,00 ₺
TE1 470	4x70	10	1.125,00 ₺
TE1 33516	3x35+16	10	1.098,00 ₺
TE1 35025	3x50+25	10	1.110,00 ₺
TE1 37035	3x70+35	10	1.120,00 ₺



T Tip
T Type No:2

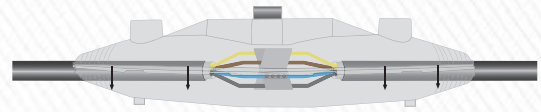

KOD CODE	KABLO KESİTİ CROSS SECTION	ADET/KOLİ UNIT/BOX	FİYAT PRICE
TE1 495	4x95	10	1.686,00 ₺
TE1 4120	4x120	1	1.715,00 ₺
TE1 4150	4x150	1	1.736,00 ₺
TE1 4185	4x185	1	1.757,00 ₺
TE1 4240	4x240	1	1.778,00 ₺
TE1 39550	3x95+50	10	1.663,00 ₺
TE1 31207	3x120+70	1	1.695,00 ₺
TE1 31507	3x150+70	1	1.715,00 ₺
TE1 31859	3x185+95	1	1.736,00 ₺
TE1 32401	3x240+120	1	1.757,00 ₺



T Tip
T Type No:1

* İstenilen kablo kesitlerine göre ek yapılır. / * Produce joint according to demand



0.6-1 kV

KOD CODE	KABLO KESİTİ CROSS SECTION	FİYAT PRICE
VDE1 410	4x10	445,00 ₺
VDE1 416	4x16	445,00 ₺
VDE1 425	4x25	466,00 ₺
VDE1 31610	3x16+10	445,00 ₺
VDE1 32516	3x25+16	466,00 ₺

0.6-1 kV



KOD CODE	KABLO KESİTİ CROSS SECTION	FİYAT PRICE
VDEX1 410	4x10	318,00 ₺
VDEX1 416	4x16	318,00 ₺
VDEX1 425	4x25	333,00 ₺
VDEX1 31610	3x16+10	318,00 ₺
VDEX1 32516	3x25+16	333,00 ₺



0.6-1 kV

KOD CODE	KABLO KESİTİ CROSS SECTION	FİYAT PRICE
VDE1 435	4x35	753,00 ₺
VDE1 450	4x50	753,00 ₺
VDE1 470	4x70	783,00 ₺
VDE1 33516	3x35+16	753,00 ₺
VDE1 35025	3x50+25	753,00 ₺
VDE1 37035	3x70+35	783,00 ₺

0.6-1 kV



KOD CODE	KABLO KESİTİ CROSS SECTION	FİYAT PRICE
VDEX1 435	4x35	530,00 ₺
VDEX1 450	4x50	530,00 ₺
VDEX1 470	4x70	544,00 ₺
VDEX1 33516	3x35+16	530,00 ₺
VDEX1 35025	3x50+25	530,00 ₺
VDEX1 37035	3x70+35	544,00 ₺



0.6-1 kV

KOD CODE	KABLO KESİTİ CROSS SECTION	FİYAT PRICE
VDE1 495	4x95	955,00 ₺
VDE1 4120	4x120	1.206,00 ₺
VDE1 4150	4x150	1.355,00 ₺
VDE1 4185	4x185	1.355,00 ₺
VDE1 4240	4x240	1.355,00 ₺
VDE1 39550	3x95+50	955,00 ₺
VDE1 31207	3x120+70	1.006,00 ₺
VDE1 31507	3x150+70	1.355,00 ₺
VDE1 31859	3x185+95	1.355,00 ₺
VDE1 32401	3x240+120	1.355,00 ₺

0.6-1 kV



KOD CODE	KABLO KESİTİ CROSS SECTION	FİYAT PRICE
VDEX1 495	4x95	635,00 ₺
VDEX1 4120	4x120	865,00 ₺
VDEX1 4150	4x150	865,00 ₺
VDEX1 4185	4x185	865,00 ₺
VDEX1 4240	4x240	865,00 ₺
VDEX1 39550	3x95+50	635,00 ₺
VDEX1 31207	3x120+70	865,00 ₺
VDEX1 31507	3x150+70	865,00 ₺
VDEX1 31859	3x185+95	865,00 ₺
VDEX1 32401	3x240+120	865,00 ₺

Y BRANŞMAN VIDALI ŞEFFAF REÇİNELİ KABLO EK MUFLARI

Y TYPE SCREW TRANSPARENT RESIN CABLE JOINTS



0.6-1 kV

KOD CODE	KABLO KESİTİ CROSS SECTION	FİYAT PRICE
VYE1 410	4x10	541,00 ₺
VYE1 416	4x16	541,00 ₺
VYE1 425	4x25	562,00 ₺
VYE1 31610	3x16+10	541,00 ₺
VYE1 32516	3x25+16	562,00 ₺

0.6-1 kV



KOD CODE	KABLO KESİTİ CROSS SECTION	FİYAT PRICE
VYEX1 410	4x10	490,00 ₺
VYEX1 416	4x16	490,00 ₺
VYEX1 425	4x25	511,00 ₺
VYEX1 31610	3x16+10	490,00 ₺
VYEX1 32516	3x25+16	511,00 ₺



0.6-1 kV

KOD CODE	KABLO KESİTİ CROSS SECTION	FİYAT PRICE
VYE1 435	4x35	825,00 ₺
VYE1 450	4x50	825,00 ₺
VYE1 470	4x70	838,00 ₺
VYE1 33516	3x35+16	825,00 ₺
VYE1 35025	3x50+25	825,00 ₺
VYE1 37035	3x70+35	838,00 ₺



0.6-1 kV



KOD CODE	KABLO KESİTİ CROSS SECTION	FİYAT PRICE
VYEX1 435	4x35	750,00 ₺
VYEX1 450	4x50	750,00 ₺
VYEX1 470	4x70	772,00 ₺
VYEX1 33516	3x35+16	750,00 ₺
VYEX1 35025	3x50+25	750,00 ₺
VYEX1 37035	3x70+35	772,00 ₺



0.6-1 kV

KOD CODE	KABLO KESİTİ CROSS SECTION	FİYAT PRICE
VYE1 495	4x95	1.175,00 ₺
VYE1 4120	4x120	1.200,00 ₺
VYE1 39550	3x95+50	1.175,00 ₺
VYE1 31207	3x120+70	1.200,00 ₺

0.6-1 kV



KOD CODE	KABLO KESİTİ CROSS SECTION	FİYAT PRICE
VYEX1 495	4x95	1.070,00 ₺
VYEX1 4120	4x120	1.095,00 ₺
VYEX1 39550	3x95+50	1.070,00 ₺
VYEX1 31207	3x120+70	1.095,00 ₺



0.6-1 kV

KOD CODE	KABLO KESİTİ CROSS SECTION	FİYAT PRICE
VYE1 4150	4x150	1.935,00 ₺
VYE1 4185	4x185	1.935,00 ₺
VYE1 4240	4x240	1.945,00 ₺
VYE1 31507	3x150+70	1.935,00 ₺
VYE1 31859	3x185+95	1.935,00 ₺
VYE1 32401	3x240+120	1.945,00 ₺

0.6-1 kV



KOD CODE	KABLO KESİTİ CROSS SECTION	FİYAT PRICE
VYEX1 4150	4x150	1.580,00 ₺
VYEX1 4185	4x185	1.580,00 ₺
VYEX1 4240	4x240	1.595,00 ₺
VYEX1 31507	3x150+70	1.580,00 ₺
VYEX1 31859	3x185+95	1.580,00 ₺
VYEX1 32401	3x240+120	1.595,00 ₺



KOD CODE	KABLO KESİTİ CROSS SECTION	FİYAT PRICE
E6 125	1x25+16	950,00 ₺
E6 135	1x35+16	950,00 ₺
E6 150	1x50+16	950,00 ₺
E6 170	1x70+16	950,00 ₺
E6 195	1x95+16	950,00 ₺
E6 1120	1x120+16	1.005,00 ₺
E6 1150	1x150+25	1.005,00 ₺
E6 1185	1x185+25	1.020,00 ₺
E6 1240	1x240+25	1.020,00 ₺
E6 1300	1x300+25	1.110,00 ₺



KOD CODE	KABLO KESİTİ CROSS SECTION	FİYAT PRICE
E10 125	1x25+16	950,00 ₺
E10 135	1x35+16	950,00 ₺
E10 150	1x50+16	950,00 ₺
E10 170	1x70+16	950,00 ₺
E10 195	1x95+16	950,00 ₺
E10 1120	1x120+16	1.005,00 ₺
E10 1150	1x150+25	1.005,00 ₺
E10 1185	1x185+25	1.020,00 ₺
E10 1240	1x240+25	1.020,00 ₺
E10 1300	1x300+25	1.110,00 ₺

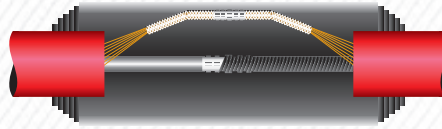

KOD CODE	KABLO KESİTİ CROSS SECTION	FİYAT PRICE
E15 125	1x25+16	950,00 ₺
E15 135	1x35+16	950,00 ₺
E15 150	1x50+16	950,00 ₺
E15 170	1x70+16	950,00 ₺
E15 195	1x95+16	950,00 ₺
E15 1120	1x120+16	1.005,00 ₺
E15 1150	1x150+25	1.005,00 ₺
E15 1185	1x185+25	1.020,00 ₺
E15 1240	1x240+25	1.020,00 ₺
E15 1300	1x300+25	1.110,00 ₺



KOD CODE	KABLO KESİTİ CROSS SECTION	FİYAT PRICE
E36 125	1x25+16	1.630,00 ₺
E36 135	1x35+16	1.630,00 ₺
E36 150	1x50+16	1.630,00 ₺
E36 170	1x70+16	1.630,00 ₺
E36 195	1x95+16	1.630,00 ₺
E36 1120	1x120+16	1.695,00 ₺
E36 1150	1x150+25	1.695,00 ₺
E36 1185	1x185+25	1.720,00 ₺
E36 1240	1x240+25	1.720,00 ₺
E36 1300	1x300+25	1.720,00 ₺

O.G. ÜÇ DAMARLI REÇİNELİ KABLO EK MUFLARI

M.V. THREE CORES RESIN CABLE JOINTS

Reçineli
Ek Muflar



3.5-6 kV



5.8-10 kV

KOD CODE	KABLO KESİTİ CROSS SECTION	FİYAT PRICE
E6 325	3x25+16	3.325,00 ₺
E6 335	3x35+16	3.325,00 ₺
E6 350	3x50+16	3.325,00 ₺
E6 370	3x70+16	3.490,00 ₺
E6 395	3x95+16	3.490,00 ₺
E6 3120	3x120+16	3.550,00 ₺
E6 3150	3x150+25	3.550,00 ₺
E6 3185	3x185+25	3.595,00 ₺
E6 3240	3x240+25	3.595,00 ₺
E6 3300	3x300+25	3.657,00 ₺

KOD CODE	KABLO KESİTİ CROSS SECTION	FİYAT PRICE
E10 325	3x25+16	3.325,00 ₺
E10 335	3x35+16	3.325,00 ₺
E10 350	3x50+16	3.325,00 ₺
E10 370	3x70+16	3.490,00 ₺
E10 395	3x95+16	3.490,00 ₺
E10 3120	3x120+16	3.550,00 ₺
E10 3150	3x150+25	3.550,00 ₺
E10 3185	3x185+25	3.595,00 ₺
E10 3240	3x240+25	3.595,00 ₺
E10 3300	3x300+25	3.657,00 ₺

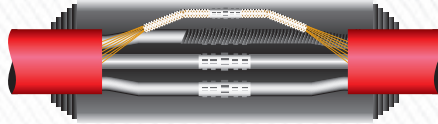

8.7-15 kV



20.8-36 kV

KOD CODE	KABLO KESİTİ CROSS SECTION	FİYAT PRICE
E15 325	3x25+16	3.325,00 ₺
E15 335	3x35+16	3.325,00 ₺
E15 350	3x50+16	3.325,00 ₺
E15 370	3x70+16	3.490,00 ₺
E15 395	3x95+16	3.490,00 ₺
E15 3120	3x120+16	3.550,00 ₺
E15 3150	3x150+25	3.550,00 ₺
E15 3185	3x185+25	3.595,00 ₺
E15 3240	3x240+25	3.595,00 ₺
E15 3300	3x300+25	3.657,00 ₺

KOD CODE	KABLO KESİTİ CROSS SECTION	FİYAT PRICE
E36 335	3x35+16	7.615,00 ₺
E36 350	3x50+16	7.615,00 ₺
E36 370	3x70+16	7.660,00 ₺
E36 395	3x95+16	7.660,00 ₺
E36 3120	3x120+16	7.678,00 ₺
E36 3150	3x150+25	7.678,00 ₺
E36 3185	3x185+25	7.840,00 ₺
E36 3240	3x240+25	7.840,00 ₺
E36 3300	3x300+25	8.000,00 ₺



0.6-1 kV

KOD CODE	KABLO KESİTİ CROSS SECTION	FİYAT PRICE
PSİLDE1 410	4x10	545,00 ₺
PSİLDE1 416	4x16	545,00 ₺
PSİLDE1 425	4x25	596,00 ₺
PSİLDE1 31610	3x16+10	545,00 ₺
PSİLDE1 32516	3x25+16	596,00 ₺

0.6-1 kV



KOD CODE	KABLO KESİTİ CROSS SECTION	FİYAT PRICE
PSİLDEX1 410	4x10	450,00 ₺
PSİLDEX1 416	4x16	450,00 ₺
PSİLDEX1 425	4x25	450,00 ₺
PSİLDEX1 31610	3x16+10	450,00 ₺
PSİLDEX1 32516	3x25+16	450,00 ₺



0.6-1 kV

KOD CODE	KABLO KESİTİ CROSS SECTION	FİYAT PRICE
PSİLDE1 435	4x35	871,00 ₺
PSİLDE1 450	4x50	871,00 ₺
PSİLDE1 470	4x70	871,00 ₺
PSİLDE1 33516	3x35+16	868,00 ₺
PSİLDE1 35025	3x50+25	868,00 ₺
PSİLDE1 37035	3x70+35	868,00 ₺



0.6-1 kV



KOD CODE	KABLO KESİTİ CROSS SECTION	FİYAT PRICE
PSİLDEX1 435	4x35	730,00 ₺
PSİLDEX1 450	4x50	730,00 ₺
PSİLDEX1 470	4x70	730,00 ₺
PSİLDEX1 33516	3x35+16	730,00 ₺
PSİLDEX1 35025	3x50+25	730,00 ₺
PSİLDEX1 37035	3x70+35	730,00 ₺



0.6-1 kV

KOD CODE	KABLO KESİTİ CROSS SECTION	FİYAT PRICE
PSİLDE1 495	4x95	1.066,00 ₺
PSİLDE1 4120	4x120	1.130,00 ₺
PSİLDE1 4150	4x150	1.340,00 ₺
PSİLDE1 4185	4x185	1.500,00 ₺
PSİLDE1 4240	4x240	1.590,00 ₺
PSİLDE1 39550	3x95+50	1.063,00 ₺
PSİLDE1 31207	3x120+70	1.127,00 ₺
PSİLDE1 31507	3x150+70	1.337,00 ₺
PSİLDE1 31859	3x185+95	1.497,00 ₺
PSİLDE1 32401	3x240+120	1.587,00 ₺

0.6-1 kV



KOD CODE	KABLO KESİTİ CROSS SECTION	FİYAT PRICE
PSİLDEX1 495	4x95	860,00 ₺
PSİLDEX1 4120	4x120	934,00 ₺
PSİLDEX1 4150	4x150	1.122,00 ₺
PSİLDEX1 4185	4x185	1.220,00 ₺
PSİLDEX1 4240	4x240	1.405,00 ₺
PSİLDEX1 39550	3x95+50	856,00 ₺
PSİLDEX1 31207	3x120+70	932,00 ₺
PSİLDEX1 31507	3x150+70	1.120,00 ₺
PSİLDEX1 31859	3x185+95	1.215,00 ₺
PSİLDEX1 32401	3x240+120	1.400,00 ₺

YENİLENEBİLİR Y BRANŞMAN VİDALI ŞEFFAF KABLO EK MUFLARI

RENEWABLE Y TYPE SCREW TRANSPARENT CABLE JOINTS



0.6-1 kV

KOD CODE	KABLO KESİTİ CROSS SECTION	FİYAT PRICE
PSİLYE1 410	4x10	790,00 ₺
PSİLYE1 416	4x16	790,00 ₺
PSİLYE1 425	4x25	835,00 ₺
PSİLYE1 31610	3x16+10	790,00 ₺
PSİLYE1 32516	3x25+16	835,00 ₺



0.6-1 kV

KOD CODE	KABLO KESİTİ CROSS SECTION	FİYAT PRICE
PSİLYEX1 410	4x10	650,00 ₺
PSİLYEX1 416	4x16	650,00 ₺
PSİLYEX1 425	4x25	650,00 ₺
PSİLYEX1 31610	3x16+10	650,00 ₺
PSİLYEX1 32516	3x25+16	650,00 ₺



0.6-1 kV

KOD CODE	KABLO KESİTİ CROSS SECTION	FİYAT PRICE
PSİLYE1 435	4x35	1.176,00 ₺
PSİLYE1 450	4x50	1.176,00 ₺
PSİLYE1 470	4x70	1.185,00 ₺
PSİLYE1 33516	3x35+16	1.176,00 ₺
PSİLYE1 35025	3x50+25	1.176,00 ₺
PSİLYE1 37035	3x70+35	1.185,00 ₺



0.6-1 kV

KOD CODE	KABLO KESİTİ CROSS SECTION	FİYAT PRICE
PSİLYEX1 435	4x35	945,00 ₺
PSİLYEX1 450	4x50	945,00 ₺
PSİLYEX1 470	4x70	945,00 ₺
PSİLYEX1 33516	3x35+16	945,00 ₺
PSİLYEX1 35025	3x50+25	945,00 ₺
PSİLYEX1 37035	3x70+35	945,00 ₺



0.6-1 kV

KOD CODE	KABLO KESİTİ CROSS SECTION	FİYAT PRICE
PSİLYE1 495	4x95	1.610,00 ₺
PSİLYE1 4120	4x120	1.625,00 ₺
PSİLYE1 39550	3x95+50	1.610,00 ₺
PSİLYE1 31207	3x120+70	1.625,00 ₺

0.6-1 kV

KOD CODE	KABLO KESİTİ CROSS SECTION	FİYAT PRICE
PSİLYEX1 495	4x95	1.320,00 ₺
PSİLYEX1 4120	4x120	1.320,00 ₺
PSİLYEX1 39550	3x95+50	1.320,00 ₺
PSİLYEX1 31207	3x120+70	1.320,00 ₺



0.6-1 kV

KOD CODE	KABLO KESİTİ CROSS SECTION	FİYAT PRICE
PSİLYE1 4150	4x150	2.315,00 ₺
PSİLYE1 4185	4x185	2.315,00 ₺
PSİLYE1 4240	4x240	2.315,00 ₺
PSİLYE1 31507	3x150+70	2.325,00 ₺
PSİLYE1 31859	3x185+95	2.325,00 ₺
PSİLYE1 32401	3x240+120	2.325,00 ₺

0.6-1 kV

KOD CODE	KABLO KESİTİ CROSS SECTION	FİYAT PRICE
PSİLYEX1 4150	4x150	1.935,00 ₺
PSİLYEX1 4185	4x185	1.935,00 ₺
PSİLYEX1 4240	4x240	1.935,00 ₺
PSİLYEX1 31507	3x150+70	1.935,00 ₺
PSİLYEX1 31859	3x185+95	1.935,00 ₺
PSİLYEX1 32401	3x240+120	1.935,00 ₺

0.6-1 kV

KOD CODE	KABLO KESİTİ CROSS SECTION	FIYAT PRICE
PSILTE1 4120	4x120	2.315,00 ₺
PSILTE1 4150	4x150	2.315,00 ₺
PSILTE1 4185	4x185	2.315,00 ₺
PSILTE1 4240	4x240	2.315,00 ₺
PSILTE1 31207	3x120+70	2.325,00 ₺
PSILTE1 31507	3x150+70	2.325,00 ₺
PSILTE1 31859	3x185+95	2.325,00 ₺
PSILTE1 32401	3x240+120	2.325,00 ₺



YENİLENEBİLİR ESNEK DOLGULU REÇİNELER

RENEWABLE FLEXIBLE RESINS FILLED



500 gr

KOD CODE	AĞIRLIK WEIGHT	ADET/KOLİ UNIT/BOX	FİYAT PRICE
PSİL 500	500 gr.	45	117,00 ₺



2 kg

KOD CODE	AĞIRLIK WEIGHT	ADET/KOLİ UNIT/BOX	FİYAT PRICE
PSİL 2000	2000 gr.	16	350,00 ₺



1 kg

KOD CODE	AĞIRLIK WEIGHT	ADET/KOLİ UNIT/BOX	FİYAT PRICE
PSİL 1000	1000 gr.	24	205,00 ₺



3 kg

KOD CODE	AĞIRLIK WEIGHT	ADET/KOLİ UNIT/BOX	FİYAT PRICE
PSİL 3000	3000 gr.	6	605,00 ₺



1.5 kg

KOD CODE	AĞIRLIK WEIGHT	ADET/KOLİ UNIT/BOX	FİYAT PRICE
PSİL 1500	1500 gr.	16	315,00 ₺



4 kg

KOD CODE	AĞIRLIK WEIGHT	ADET/KOLİ UNIT/BOX	FİYAT PRICE
PSİL 4000	4000 gr.	6	660,00 ₺

20 kg



KOD CODE	AĞIRLIK WEIGHT	ADET/KOLİ UNIT/BOX	FİYAT PRICE
PSİL 20000	20 kg.	1	3.260,00 ₺



210 GR

KOD CODE	AĞIRLIK WEIGHT	ADET/KOLİ UNIT/BOX	FİYAT PRICE
PRO 210	210 GR	100	56,00 ₺



300 GR

KOD CODE	AĞIRLIK WEIGHT	ADET/KOLİ UNIT/BOX	FİYAT PRICE
PRO 300	300 GR	50	65,00 ₺



500 GR

KOD CODE	AĞIRLIK WEIGHT	ADET/KOLİ UNIT/BOX	FİYAT PRICE
PRO 500	500 GR	45	91,00 ₺



600 GR

KOD CODE	AĞIRLIK WEIGHT	ADET/KOLİ UNIT/BOX	FİYAT PRICE
PRO 600	600 GR	45	115,00 ₺



1 KG

KOD CODE	AĞIRLIK WEIGHT	ADET/KOLİ UNIT/BOX	FİYAT PRICE
PRO 1000	1KG	24	165,00 ₺



1.5 KG

KOD CODE	AĞIRLIK WEIGHT	ADET/KOLİ UNIT/BOX	FİYAT PRICE
PRO 1500	1,5KG	16	245,00 ₺



2 KG

KOD CODE	AĞIRLIK WEIGHT	ADET/KOLİ UNIT/BOX	FİYAT PRICE
PRO 2000	2KG	16	320,00 ₺



3 KG

KOD CODE	AĞIRLIK WEIGHT	ADET/KOLİ UNIT/BOX	FİYAT PRICE
PRO 3000	3KG	6	485,00 ₺



4 KG

KOD CODE	AĞIRLIK WEIGHT	ADET/KOLİ UNIT/BOX	FİYAT PRICE
PRO 4000	4KG	6	570,00 ₺



20 KG

KOD CODE	AĞIRLIK WEIGHT	ADET/KOLİ UNIT/BOX	FİYAT PRICE
PRO 20000	20KG	1	2.775,00 ₺



AG & OG
İzolasyon
Kapamalarında
Ortak Çözüm...

tamflex[®]



tamflex®



0.6-1 kV

AG BUŞING KAPAMALAR
LV BUSHING COVERING

KOD CODE	UYGUN TRAFO SUITABLE TRANSF.	Akım-Amper (A) CURRENT (A)	ADET/UNIT	FİYAT PRICE
TBK-01	1kV,1000-1600kVA	2000-3150A	1	195,00 ₺
TBK-05	1kV, 500-800kVA	1000-1250A	1	175,00 ₺
TBK-04	1kV, 200-400kVA	630A	1	155,00 ₺
TBK-06	1kV, 50-160kVA	250A	1	145,00 ₺



OG HAVAİ HAT KAPAMALAR
MV OVERHEAD-LINE PROTECTION



20.8-36 kV

KOD CODE	İLETKEN TİPİ CONDUCTOR TYPE	MAKSİMUM İLETKEN ÇAPI MAX CONDUCTOR SIZE	METRE/ METER	FİYAT PRICE
THK-01	Swallow (3) Tırnaklı Tip	16,50	1	71,00 ₺
	Raven(1/0) Tırnaklı Tip			
	Piegon (3/0) Tırnaklı Tip			
	Sparrow (2) Tırnaklı Tip			
THK-02	Hawk-477-Tırnaklı Tip	37	1	135,00 ₺
THK-03	Swallow (3), Raven(1/0), Sparrow (2)	-	1	155,00 ₺
THK-04	Swallow (3), Raven(1/0), Sparrow (2) -Borulu Tip	12	1	56,00 ₺
THK-05	Piegon (3/0)-Borulu Tip	17	1	67,00 ₺
THK-06	Swallow (3)-Tırnaklı Tip	13	1	71,00 ₺
THK-07	Hawk-477-Borulu Tip	29	1	112,00 ₺



tamflex bir
TAMER Elektrik Markasıdır.

tamflex®

OG BUŞING KAPAMA
MV BUSHING COVERING

20.8-36 kV



KOD CODE	UYGUN TRAFÖ SUITABLE TRANSF.	Akım-Amper (A) CURRENT (A)	ADET/UNIT	FİYAT PRICE
TBK-02	36kV,10-1600kVA	250-3150A	1	232,00 ₺

OG VHD İZOLATÖR KAPAMALAR
MV VHD INSULATOR COVERING

20.8-36 kV

KOD CODE	UYGUN İZOLATÖR SUITABLE INSULATOR	ADET/UNIT	FİYAT PRICE
TBK-03 Ortadan Kollu Borulu	36kV, VHD-35 SII	1	330,00 ₺
TBKX-03 Ortadan Kollu Borusuz	36kV, VHD-35 SII	1	252,00 ₺
TBK-03 Uçlu Ortadan Kollu Borulu	36kV, VHD-35 SII	1	365,00 ₺
TBK-03 Uçlu Ortadan Kollu Borusuz	36kV, VHD-35 SII	1	280,00 ₺
TBK-03 Yandan Kollu	36kV, VHD-35 SII	1	336,00 ₺



OG PARAFUDR KAPAMA
MV PARAFUDR COVERING

20.8-36 kV

KOD CODE	UYGUN TRAFÖ SUITABLE TRANSF.	Akım-Amper (A) CURRENT (A)	ADET/ UNIT	FİYAT PRICE (m/₺)
TPK-01	36kV,10-1600kVA	250-3150A	1	110,00 ₺





0.6-1 kV

0.6-1 kV



KOD CODE	KABLO KESİTİ CROSS SECTION	FİYAT PRICE
S1 4105	4x1,5	71,00 ₺
S1 4205	4x2,5	71,00 ₺
S1 404	4x4	71,00 ₺
S1 406	4x6	71,00 ₺
S1 410	4x10	95,00 ₺
S1 416	4x16	95,00 ₺
S1 425	4x25	143,00 ₺
S1 435	4x35	154,00 ₺
S1 450	4x50	166,00 ₺
S1 470	4x70	247,00 ₺
S1 495	4x95	283,00 ₺
S1 4120	4x120	354,00 ₺
S1 4150	4x150	440,00 ₺
S1 4185	4x185	702,00 ₺
S1 4240	4x240	734,00 ₺
S1 4300	4x300	802,00 ₺
S1 4400	4x400	910,00 ₺
S1 31610	3x16+10	94,00 ₺
S1 32516	3x25+16	139,00 ₺
S1 33516	3x35+16	150,00 ₺
S1 35025	3x50+25	161,00 ₺
S1 37035	3x70+35	242,00 ₺
S1 39550	3x95+50	265,00 ₺
S1 31207	3x120+70	345,00 ₺
S1 31507	3x150+70	425,00 ₺
S1 31859	3x185+95	693,00 ₺
S1 32401	3x240+120	726,00 ₺
S1 33001	3x300+150	785,00 ₺
S1 34001	3x400+185	890,00 ₺

KOD CODE	KABLO KESİTİ CROSS SECTION	FİYAT PRICE
S1 315	3x1,5	68,00 ₺
S1 304	3x4	68,00 ₺
S1 306	3x6	68,00 ₺
S1 310	3x10	90,00 ₺
S1 316	3x16	90,00 ₺
S1 325	3x25	136,00 ₺
S1 335	3x35	146,00 ₺
S1 350	3x50	158,00 ₺
S1 370	3x70	238,00 ₺
S1 395	3x95	264,00 ₺
S1 3120	3x120	332,00 ₺
S1 3150	3x150	393,00 ₺
S1 3185	3x185	680,00 ₺
S1 3240	3x240	713,00 ₺
S1 3300	3x300	770,00 ₺
S1 3400	3x400	875,00 ₺

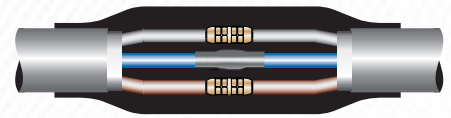

* İstenilen kablo kesitlerine göre ek yapılır. / * Produce joint according to demand

ISI BÜZÜŞMELİ KABLO EK MUFLARI

HEAT SHRINKABLE CABLE JOINTS

BAKIR İLETKENLER İÇİN
FOR COPPER CONNECTORS



0.6-1 kV

KOD CODE	KABLO KESİTİ CROSS SECTION	FİYAT PRICE
S1 5105 - S1 5205	5x1,5 - 5x2,5	77,00 ₺
S1 504 - S1 506	5x4 - 5x6	77,00 ₺
S1 510 - S1 516	5x10 - 5x16	100,00 ₺
S1 525	5x25	170,00 ₺
S1 535	5x35	235,00 ₺
S1 550	5x50	258,00 ₺
S1 570	5x70	285,00 ₺
S1 595	5x95	307,00 ₺
S1 5120	5x120	455,00 ₺
S1 5150	5x150	485,00 ₺
S1 5185	5x185	765,00 ₺
S1 5240	5x240	812,00 ₺
S1 715 - S1 725	7x1,5 - 7x2,5	84,00 ₺
S1 1015 - S1 1025	10x1,5 - 10x2,5	123,00 ₺
S1 1215 - S1 1225	12 x1,5 - 12x2,5	163,00 ₺

0.6-1 kV



KOD CODE	KABLO KESİTİ CROSS SECTION	FİYAT PRICE
S1 215 - S1 204	2x1,5 - 2x4	58,00 ₺
S1 206 - S1 210	2x6 - 2x10	58,00 ₺
S1 216 - S1 225	2x16 - 2x25	62,00 ₺
S1 235 - S1 250	2x35 - 2x50	140,00 ₺
S1 270 - S1 295	2x70 - 2x95	227,00 ₺
S1 2120 - S1 2150	2x120 - 2x150	288,00 ₺
S1 2185	2x185	346,00 ₺
S1 2240	2x240	360,00 ₺
S1 2300	2x300	375,00 ₺
S1 2400	2x400	436,00 ₺

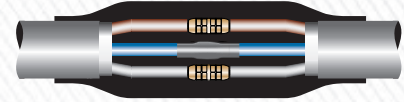

0.6-1 kV

KOD CODE	KABLO KESİTİ CROSS SECTION	FİYAT PRICE
S1 115 - S1 104	104 1x1,5 - 1x4	47,00 ₺
S1 106 - S1 110	1x6 - 1x10	47,00 ₺
S1 116 - S1 125	1x16 - 1x25	53,00 ₺
S1 135 - S1 150	1x35 - 1x50	70,00 ₺
S1 170 - S1 195	1x70 - 1x95	96,00 ₺
S1 1120 - S1 1150	1x120 - 1x150	115,00 ₺
S1 1185 - S1 1240	1x185 - 1x240	140,00 ₺
S1 1300 - S1 1400	1x300 - 1x400	175,00 ₺



KOD CODE	KABLO KESİTİ CROSS SECTION	FİYAT PRICE
AS1 410	4x10	92,00 ₺
AS1 416	4x16	92,00 ₺
AS1 425	4x25	137,00 ₺
AS1 435	4x35	150,00 ₺
AS1 450	4x50	162,00 ₺
AS1 470	4x70	242,00 ₺
AS1 495	4x95	264,00 ₺
AS1 4120	4x120	347,00 ₺
AS1 4150	4x150	420,00 ₺
AS1 4185	4x185	695,00 ₺
AS1 4240	4x240	730,00 ₺
AS1 4300	4x300	790,00 ₺
AS1 4400	4x400	900,00 ₺
AS1 31610	3x16+10	92,00 ₺
AS1 32516	3x25+16	135,00 ₺
AS1 33516	3x35+16	146,00 ₺
AS1 35025	3x50+25	158,00 ₺
AS1 37035	3x70+35	239,00 ₺
AS1 39550	3x95+50	261,00 ₺
AS1 31207	3x120+70	340,00 ₺
AS1 31507	3x150+70	405,00 ₺
AS1 31859	3x185+95	680,00 ₺
AS1 32401	3x240+120	716,00 ₺
AS1 33001	3x300+150	775,00 ₺
AS1 34001	3x400+185	880,00 ₺

KOD CODE	KABLO KESİTİ CROSS SECTION	FİYAT PRICE
AS1 310	3x10	87,00 ₺
AS1 316	3x16	87,00 ₺
AS1 325	3x25	132,00 ₺
AS1 335	3x35	145,00 ₺
AS1 350	3x50	154,00 ₺
AS1 370	3x70	234,00 ₺
AS1 395	3x95	258,00 ₺
AS1 3120	3x120	327,00 ₺
AS1 3150	3x150	381,00 ₺
AS1 3185	3x185	671,00 ₺
AS1 3240	3x240	700,00 ₺
AS1 3300	3x300	760,00 ₺
AS1 3400	3x400	865,00 ₺

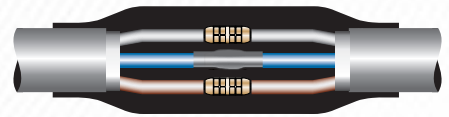

ALÜMİNYUM İLETKENLER İÇİN ISI BÜZÜŞMELİ KABLO EK MUFLARI

FOR ALUMINUM CONNECTORS HEAT SHRINKABLE CABLE JOINTS

ALÜMİNYUM İLETKENLER İÇİN FOR ALUMINUM CONNECTORS

KOD CODE	KABLO KESİTİ CROSS SECTION	FİYAT PRICE
AS1 510 - S1 516	5x10 - 5x16	96,00 ₺
AS1 525	5x25	165,00 ₺
AS1 535	5x35	225,00 ₺
AS1 550	5x50	249,00 ₺
AS1 570	5x70	275,00 ₺
AS1 595	5x95	297,00 ₺
AS1 5120	5x120	445,00 ₺
AS1 5150	5x150	475,00 ₺
AS1 5185	5x185	755,00 ₺
AS1 5240	5x240	798,00 ₺

0.6-1 kV



KOD CODE	KABLO KESİTİ CROSS SECTION	FİYAT PRICE
AS1 216	2x16	56,00 ₺
AS1 225	2x25	56,00 ₺
AS1 235 - AS1 250	2x35 - 2x50	135,00 ₺
AS1 270 - AS1 295	2x70 - 2x95	223,00 ₺
AS1 2120 - AS1 2150	2x120 - 2x150	280,00 ₺
AS1 2185	2x185	336,00 ₺
AS1 2240	2x240	348,00 ₺
AS1 2300	2x300	366,00 ₺
AS1 2400	2x400	427,00 ₺

0.6-1 kV

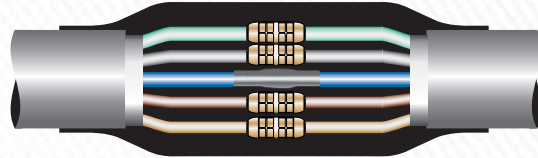

KOD CODE	KABLO KESİTİ CROSS SECTION	FİYAT PRICE
AS1 125	1x25	48,00 ₺
AS1 135 - AS1 150	1x35 - 1x50	65,00 ₺
AS1 170 - AS1 195	1x70 - 1x95	92,00 ₺
AS1 1120 - AS1 1150	1x120 - 1x150	107,00 ₺
AS1 1185 - AS1 1240	1x185 - 1x240	130,00 ₺
AS1 1300 - AS1 1400	1x300 - 1x400	165,00 ₺

0.6-1 kV



0.6-1 kV



KOD CODE	KABLO KESİTİ CROSS SECTION	FİYAT PRICE
FS1 31610	3x16+10	363,00 ₺
FS1 32516	3x25+16	380,00 ₺
FS1 33516	3x35+16	387,00 ₺
FS1 35025	3x50+25	397,00 ₺
FS1 37035	3x70+35	507,00 ₺
FS1 39550	3x95+50	521,00 ₺
FS1 31207	3x120+70	625,00 ₺
FS1 31507	3x150+70	647,00 ₺
FS1 31859	3x185+95	773,00 ₺
FS1 32401	3x240+120	851,00 ₺
FS1 33001	3x300+150	1.025,00 ₺
FS1 34001	3x400+185	1.137,00 ₺
FS1 4105	4x1,5	320,00 ₺
FS1 4205	4x2,5	320,00 ₺
FS1 404	4x4	320,00 ₺
FS1 406	4x6	320,00 ₺
FS1 410	4x10	343,00 ₺
FS1 416	4x16	363,00 ₺
FS1 425	4x25	387,00 ₺
FS1 435	4x35	393,00 ₺
FS1 450	4x50	403,00 ₺
FS1 470	4x70	518,00 ₺
FS1 495	4x95	534,00 ₺
FS1 4120	4x120	635,00 ₺
FS1 4150	4x150	661,00 ₺
FS1 4185	4x185	785,00 ₺
FS1 4240	4x240	863,00 ₺
FS1 4300	4x300	1.042,00 ₺
FS1 4400	4x400	1.160,00 ₺

KOD CODE	KABLO KESİTİ CROSS SECTION	FİYAT PRICE
FS1 5105-FS1 5205	5x1,5-5x2,5	340,00 ₺
FS1 504-FS1 506	5x4-5x6	340,00 ₺
FS1 510	5x10	363,00 ₺
FS1 516	5x16	390,00 ₺
FS1 525	5x25	415,00 ₺
FS1 535	5x35	430,00 ₺
FS1 550	5x50	507,00 ₺
FS1 570	5x70	555,00 ₺
FS1 595	5x95	652,00 ₺
FS1 5120	5x120	722,00 ₺
FS1 5150	5x150	753,00 ₺
FS1 5185	5x185	975,00 ₺
FS1 5240	5x240	1.075,00 ₺

KOD CODE	KABLO KESİTİ CROSS SECTION	FİYAT PRICE
FS1 135	1x35	340,00 ₺
FS1 150	1x50	340,00 ₺
FS1 170	1x70	365,00 ₺
FS1 195	1x95	365,00 ₺
FS1 1120	1x120	405,00 ₺
FS1 1150	1x150	405,00 ₺
FS1 1185	1x185	455,00 ₺
FS1 1240	1x240	455,00 ₺
FS1 1300	1x300	530,00 ₺

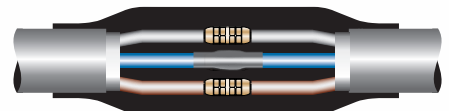

FERMUARLI ISI BÜZÜŞMELİ KABLO EK MUFLARI

REPAIR SLEEVE HEAT SHRINKABLE CABLE JOINTS

0.6-1 kV



KOD CODE	KABLO KESİTİ CROSS SECTION	FİYAT PRICE
AFS1 31610	3x16+10	358,00 ₺
AFS1 32516	3x25+16	375,00 ₺
AFS1 33516	3x35+16	382,00 ₺
AFS1 35025	3x50+25	392,00 ₺
AFS1 37035	3x70+35	502,00 ₺
AFS1 39550	3x95+50	516,00 ₺
AFS1 31207	3x120+70	620,00 ₺
AFS1 31507	3x150+70	642,00 ₺
AFS1 31859	3x185+95	768,00 ₺
AFS1 32401	3x240+120	846,00 ₺
AFS1 33001	3x300+150	1.020,00 ₺
AFS1 34001	3x400+185	1.132,00 ₺
AFS1 4105	4x1,5	315,00 ₺
AFS1 4205	4x2,5	315,00 ₺
AFS1 404	4x4	315,00 ₺
AFS1 406	4x6	315,00 ₺
AFS1 410	4x10	338,00 ₺
AFS1 416	4x16	358,00 ₺
AFS1 425	4x25	382,00 ₺
AFS1 435	4x35	388,00 ₺
AFS1 450	4x50	398,00 ₺
AFS1 470	4x70	513,00 ₺
AFS1 495	4x95	529,00 ₺
AFS1 4120	4x120	630,00 ₺
AFS1 4150	4x150	656,00 ₺
AFS1 4185	4x185	780,00 ₺
AFS1 4240	4x240	858,00 ₺
AFS1 4300	4x300	1.032,00 ₺
AFS1 4400	4x400	1.150,00 ₺

KOD CODE	KABLO KESİTİ CROSS SECTION	FİYAT PRICE
AFS1 5105-FS1 5205	5x1,5-5x2,5	335,00 ₺
AFS1 504-FS1 506	5x4-5x6	335,00 ₺
AFS1 510	5x10	358,00 ₺
AFS1 516	5x16	385,00 ₺
AFS1 525	5x25	410,00 ₺
AFS1 535	5x35	425,00 ₺
AFS1 550	5x50	502,00 ₺
AFS1 570	5x70	550,00 ₺
AFS1 595	5x95	647,00 ₺
AFS1 5120	5x120	717,00 ₺
AFS1 5150	5x150	748,00 ₺
AFS1 5185	5x185	970,00 ₺
AFS1 5240	5x240	1.070,00 ₺

KOD CODE	KABLO KESİTİ CROSS SECTION	FİYAT PRICE
AFS1 135	1x35	335,00 ₺
AFS1 150	1x50	335,00 ₺
AFS1 170	1x70	360,00 ₺
AFS1 195	1x95	360,00 ₺
AFS1 1120	1x120	400,00 ₺
AFS1 1150	1x150	400,00 ₺
AFS1 1185	1x185	450,00 ₺
AFS1 1240	1x240	450,00 ₺
AFS1 1300	1x300	520,00 ₺

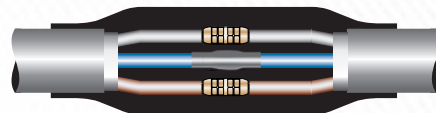

0.6-1 kV

BAKIR İLETKENLER İÇİN
FOR COPPER CONNECTORS



KOD CODE	KABLO KESİTİ CROSS SECTION	FİYAT PRICE
ZS1 4105	4x1,5	155,00 ₺
ZS1 4205	4x2,5	155,00 ₺
ZS1 404	4x4	155,00 ₺
ZS1 406	4x6	155,00 ₺
ZS1 410	4x10	175,00 ₺
ZS1 416	4x16	180,00 ₺
ZS1 425	4x25	245,00 ₺
ZS1 435	4x35	282,00 ₺
ZS1 450	4x50	295,00 ₺
ZS1 470	4x70	393,00 ₺
ZS1 495	4x95	446,00 ₺
ZS1 4120	4x120	553,00 ₺
ZS1 4150	4x150	618,00 ₺
ZS1 4185	4x185	1.091,00 ₺
ZS1 4240	4x240	1.241,00 ₺
ZS1 4300	4x300	1.322,00 ₺
ZS1 4400	4x400	1.445,00 ₺
ZS1 31610	3x16+10	175,00 ₺
ZS1 32516	3x25+16	240,00 ₺
ZS1 33516	3x35+16	277,00 ₺
ZS1 35025	3x50+25	290,00 ₺
ZS1 37035	3x70+35	388,00 ₺
ZS1 39550	3x95+50	440,00 ₺
ZS1 31207	3x120+70	545,00 ₺
ZS1 31507	3x150+70	608,00 ₺
ZS1 31859	3x185+95	971,00 ₺
ZS1 32401	3x240+120	1.080,00 ₺
ZS1 33001	3x300+150	1.300,00 ₺
ZS1 34001	3x400+185	1.415,00 ₺

0.6-1 kV

ALÜMİNYUM İLETKENLER İÇİN
FOR ALUMINUM CONNECTORS



KOD CODE	KABLO KESİTİ CROSS SECTION	FİYAT PRICE
AZS1 425	4x25	240,00 ₺
AZS1 435	4x35	247,00 ₺
AZS1 450	4x50	290,00 ₺
AZS1 470	4x70	388,00 ₺
AZS1 495	4x95	440,00 ₺
AZS1 4120	4x120	548,00 ₺
AZS1 4150	4x150	614,00 ₺
AZS1 4185	4x185	1.076,00 ₺
AZS1 4240	4x240	1.225,00 ₺
AZS1 4300	4x300	1.300,00 ₺
AZS1 4400	4x400	1.420,00 ₺
AZS1 32516	3x25+16	235,00 ₺
AZS1 33516	3x35+16	272,00 ₺
AZS1 35025	3x50+25	285,00 ₺
AZS1 37035	3x70+35	383,00 ₺
AZS1 39550	3x95+50	435,00 ₺
AZS1 31207	3x120+70	540,00 ₺
AZS1 31507	3x150+70	600,00 ₺
AZS1 31859	3x185+95	965,00 ₺
AZS1 32401	3x240+120	1.065,00 ₺
AZS1 33001	3x300+150	1.285,00 ₺
AZS1 34001	3x400+185	1.400,00 ₺

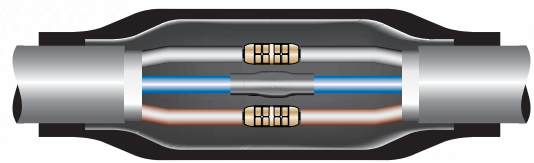

BİMETAL ISI BÜZÜŞMELİ KABLO EK MUFLARI

FOR BIMETALLIC HEAT SHRINKABLE CABLE JOINTS



0.6-1 kV

KOD CODE	KABLO KESİTİ CROSS SECTION	FİYAT PRICE
BS1 42516	4x25-4x16	320,00 ₺
BS1 43516	4x35-4x16	320,00 ₺
BS1 45025	4x50-4x25	370,00 ₺
BS1 47035	4x70-4x35	460,00 ₺
BS1 49550	4x95-4x50	593,00 ₺
BS1 412070	4x120-4x70	690,00 ₺
BS1 415095	4x150-4x95	800,00 ₺
BS1 4185120	4x185-4x120	1.260,00 ₺
BS1 4240150	4x240-4x150	1.415,00 ₺
BS1 32516	3x25+16-3x16+10	319,00 ₺
BS1 33516	3x35+16-3x25+16	319,00 ₺
BS1 35025	3x50+25-3x25+16	350,00 ₺
BS1 37035	3x70+35-3x35+16	440,00 ₺
BS1 39550	3x95+50-3x50+25	570,00 ₺
BS1 31207	3x120+70-3x70+35	675,00 ₺
BS1 31507	3x150+70-3x70+35	775,00 ₺
BS1 31859	3x185+95-3x95+50	1.235,00 ₺
BS1 32401	3x240+120-3x120+70	1.380,00 ₺

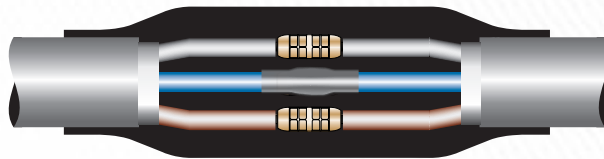



3.5-6 kV

KOD CODE	KABLO KESİTİ CROSS SECTION	KOLİ ADETİ UNIT / BOX	FİYAT PRICE
IB6 125	1x25+16	11	1.250,00 ₺
IB6 135	1x35+16	11	1.250,00 ₺
IB6 150	1x50+16	11	1.250,00 ₺
IB6 170	1x70+16	11	1.250,00 ₺
IB6 195	1x95+16	11	1.250,00 ₺
IB6 1120	1x120+16	11	1.256,00 ₺
IB6 1150	1x150+25	11	1.256,00 ₺
IB6 1185	1x185+25	11	1.270,00 ₺
IB6 1240	1x240+25	11	1.300,00 ₺
IB6 1300	1x300+25	11	1.345,00 ₺
IB6 1400	1x400+35	11	1.430,00 ₺
IB6 1500	1x500+35	11	1.440,00 ₺
IB6 1630	1x630+35	11	1.810,00 ₺

5.8-10 kV

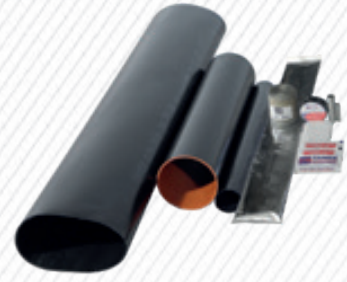

KOD CODE	KABLO KESİTİ CROSS SECTION	KOLİ ADETİ UNIT / BOX	FİYAT PRICE
IB10 125	1x25+16	11	1.250,00 ₺
IB10 135	1x35+16	11	1.250,00 ₺
IB10 150	1x50+16	11	1.250,00 ₺
IB10 170	1x70+16	11	1.250,00 ₺
IB10 195	1x95+16	11	1.250,00 ₺
IB10 1120	1x120+16	11	1.256,00 ₺
IB10 1150	1x150+25	11	1.256,00 ₺
IB10 1185	1x185+25	11	1.270,00 ₺
IB10 1240	1x240+25	11	1.300,00 ₺
IB10 1300	1x300+25	11	1.345,00 ₺
IB10 1400	1x400+35	11	1.430,00 ₺
IB10 1500	1x500+35	11	1.440,00 ₺
IB10 1630	1x630+35	11	1.810,00 ₺

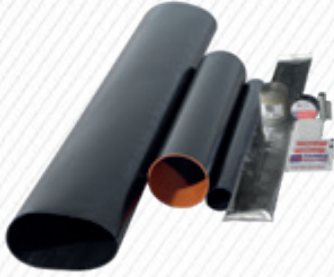

8.7-15 kV

KOD CODE	KABLO KESİTİ CROSS SECTION	KOLİ ADETİ UNIT / BOX	FİYAT PRICE
IB15 125	1x25+16	11	1.250,00 ₺
IB15 135	1x35+16	11	1.250,00 ₺
IB15 150	1x50+16	11	1.250,00 ₺
IB15 170	1x70+16	11	1.250,00 ₺
IB15 195	1x95+16	11	1.250,00 ₺
IB15 1120	1x120+16	11	1.256,00 ₺
IB15 1150	1x150+25	11	1.256,00 ₺
IB15 1185	1x185+25	11	1.270,00 ₺
IB15 1240	1x240+25	11	1.300,00 ₺
IB15 1300	1x300+25	11	1.345,00 ₺
IB15 1400	1x400+35	11	1.430,00 ₺
IB15 1500	1x500+35	11	1.440,00 ₺
IB15 1630	1x630+35	11	1.810,00 ₺

20.8-36 kV

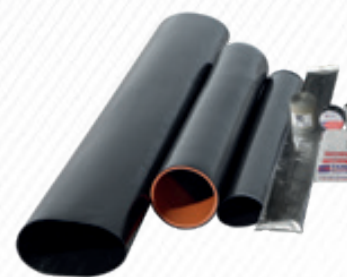

KOD CODE	KABLO KESİTİ CROSS SECTION	KOLİ ADETİ UNIT / BOX	FİYAT PRICE
IB36 125	1x25+16	11	2.130,00 ₺
IB36 135	1x35+16	11	2.130,00 ₺
IB36 150	1x50+16	11	2.130,00 ₺
IB36 170	1x70+16	11	2.130,00 ₺
IB36 195	1x95+16	11	2.130,00 ₺
IB36 1120	1x120+16	11	2.150,00 ₺
IB36 1150	1x150+25	11	2.150,00 ₺
IB36 1185	1x185+25	11	2.180,00 ₺
IB36 1240	1x240+25	11	2.180,00 ₺
IB36 1300	1x300+25	11	2.375,00 ₺
IB36 1400	1x400+35	11	2.475,00 ₺
IB36 1500	1x500+35	11	2.710,00 ₺
IB36 1630	1x630+35	11	2.990,00 ₺

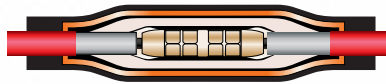

O.G. ÜÇ DAMARLI ISI BÜZÜŞMELİ KABLO EK MUFLARI

M.V. THREE CORES HEAT SHRINKABLE CABLE JOINTS



3.5-6 kV



5.8-10 kV

KOD CODE	KABLO KESİTİ CROSS SECTION	FİYAT PRICE
IB6 325	3x25+16	3.440,00 ₺
IB6 335	3x35+16	3.440,00 ₺
IB6 350	3x50+16	3.455,00 ₺
IB6 370	3x70+16	3.455,00 ₺
IB6 395	3x95+16	3.455,00 ₺
IB6 3120	3x120+16	3.460,00 ₺
IB6 3150	3x150+25	3.460,00 ₺
IB6 3185	3x185+25	3.460,00 ₺
IB6 3240	3x240+25	3.495,00 ₺
IB6 3300	3x300+25	3.635,00 ₺
IB6 3400	3x400+35	3.725,00 ₺
IB6 3500	3x500+35	3.980,00 ₺

KOD CODE	KABLO KESİTİ CROSS SECTION	FİYAT PRICE
IB10 325	3x25+16	3.440,00 ₺
IB10 335	3x35+16	3.440,00 ₺
IB10 350	3x50+16	3.455,00 ₺
IB10 370	3x70+16	3.455,00 ₺
IB10 395	3x95+16	3.455,00 ₺
IB10 3120	3x120+16	3.460,00 ₺
IB10 3150	3x150+25	3.460,00 ₺
IB10 3185	3x185+25	3.460,00 ₺
IB10 3240	3x240+25	3.495,00 ₺
IB10 3300	3x300+25	3.635,00 ₺
IB10 3400	3x400+35	3.725,00 ₺
IB10 3500	3x500+35	3.980,00 ₺



8.7-15 kV



20.8-36 kV

KOD CODE	KABLO KESİTİ CROSS SECTION	FİYAT PRICE
IB15 325	3x25+16	3.440,00 ₺
IB15 335	3x35+16	3.440,00 ₺
IB15 350	3x50+16	3.455,00 ₺
IB15 370	3x70+16	3.455,00 ₺
IB15 395	3x95+16	3.455,00 ₺
IB15 3120	3x120+16	3.460,00 ₺
IB15 3150	3x150+25	3.460,00 ₺
IB15 3185	3x185+25	3.460,00 ₺
IB15 3240	3x240+25	3.495,00 ₺
IB15 3300	3x300+25	3.635,00 ₺
IB15 3400	3x400+35	3.725,00 ₺
IB15 3500	3x500+35	3.980,00 ₺

KOD CODE	KABLO KESİTİ CROSS SECTION	FİYAT PRICE
IB36 325	3x25+16	8.240,00 ₺
IB36 335	3x35+16	8.240,00 ₺
IB36 350	3x50+16	8.240,00 ₺
IB36 370	3x70+16	8.245,00 ₺
IB36 395	3x95+16	8.245,00 ₺
IB36 3120	3x120+16	8.255,00 ₺
IB36 3150	3x150+25	8.255,00 ₺
IB36 3185	3x185+25	8.295,00 ₺
IB36 3240	3x240+25	8.345,00 ₺
IB36 3300	3x300+25	8.475,00 ₺
IB36 3400	3x400+35	8.565,00 ₺
IB36 3500	3x500+35	8.795,00 ₺

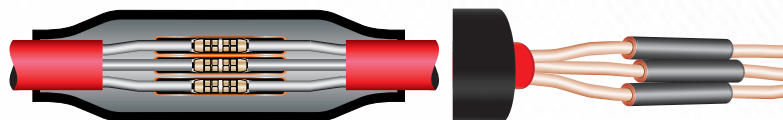

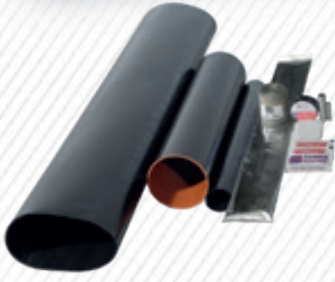

3.5-6 kV

5.8-10 kV

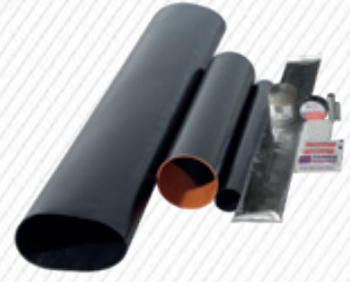

KOD CODE	KABLO KESİTİ CROSS SECTION	KOLİ ADETİ UNIT / BOX	FİYAT PRICE
IBA6 125	1x25+16	11	1.240,00 ₺
IBA6 135	1x35+16	11	1.240,00 ₺
IBA6 150	1x50+16	11	1.240,00 ₺
IBA6 170	1x70+16	11	1.240,00 ₺
IBA6 195	1x95+16	11	1.240,00 ₺
IBA6 1120	1x120+16	11	1.246,00 ₺
IBA6 1150	1x150+25	11	1.246,00 ₺
IBA6 1185	1x185+25	11	1.260,00 ₺
IBA6 1240	1x240+25	11	1.290,00 ₺
IBA6 1300	1x300+25	11	1.335,00 ₺
IBA6 1400	1x400+35	11	1.420,00 ₺
IBA6 1500	1x500+35	11	1.430,00 ₺
IBA6 1630	1x630+35	11	1.800,00 ₺

KOD CODE	KABLO KESİTİ CROSS SECTION	KOLİ ADETİ UNIT / BOX	FİYAT PRICE
IBA10 125	1x25+16	11	1.240,00 ₺
IBA10 135	1x35+16	11	1.240,00 ₺
IBA10 150	1x50+16	11	1.240,00 ₺
IBA10 170	1x70+16	11	1.240,00 ₺
IBA10 195	1x95+16	11	1.240,00 ₺
IBA10 1120	1x120+16	11	1.246,00 ₺
IBA10 1150	1x150+25	11	1.246,00 ₺
IBA10 1185	1x185+25	11	1.260,00 ₺
IBA10 1240	1x240+25	11	1.290,00 ₺
IBA10 1300	1x300+25	11	1.335,00 ₺
IBA10 1400	1x400+35	11	1.420,00 ₺
IBA10 1500	1x500+35	11	1.430,00 ₺
IBA10 1630	1x630+35	11	1.800,00 ₺

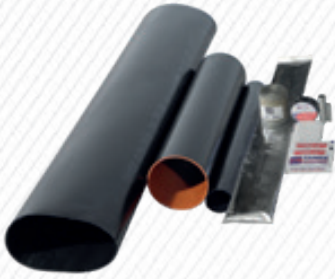

8.7-15 kV

20.8-36 kV

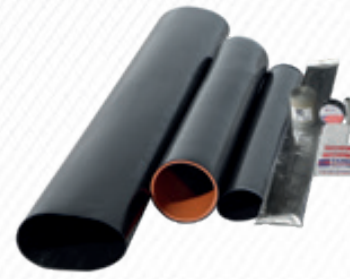

KOD CODE	KABLO KESİTİ CROSS SECTION	KOLİ ADETİ UNIT / BOX	FİYAT PRICE
IBA15 125	1x25+16	11	1.240,00 ₺
IBA15 135	1x35+16	11	1.240,00 ₺
IBA15 150	1x50+16	11	1.240,00 ₺
IBA15 170	1x70+16	11	1.240,00 ₺
IBA15 195	1x95+16	11	1.240,00 ₺
IBA15 1120	1x120+16	11	1.246,00 ₺
IBA15 1150	1x150+25	11	1.246,00 ₺
IBA15 1185	1x185+25	11	1.260,00 ₺
IBA15 1240	1x240+25	11	1.290,00 ₺
IBA15 1300	1x300+25	11	1.335,00 ₺
IBA15 1400	1x400+35	11	1.420,00 ₺
IBA15 1500	1x500+35	11	1.430,00 ₺
IBA15 1630	1x630+35	11	1.800,00 ₺

KOD CODE	KABLO KESİTİ CROSS SECTION	KOLİ ADETİ UNIT / BOX	FİYAT PRICE
IBA36 125	1x25+16	11	2.120,00 ₺
IBA36 135	1x35+16	11	2.120,00 ₺
IBA36 150	1x50+16	11	2.120,00 ₺
IBA36 170	1x70+16	11	2.120,00 ₺
IBA36 195	1x95+16	11	2.120,00 ₺
IBA36 1120	1x120+16	11	2.140,00 ₺
IBA36 1150	1x150+25	11	2.140,00 ₺
IBA36 1185	1x185+25	11	2.170,00 ₺
IBA36 1240	1x240+25	11	2.170,00 ₺
IBA36 1300	1x300+25	11	2.365,00 ₺
IBA36 1400	1x400+35	11	2.465,00 ₺
IBA36 1500	1x500+35	11	2.700,00 ₺
IBA36 1630	1x630+35	11	2.980,00 ₺

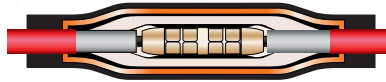

O.G. ALÜMİNYUM ÜÇ DAMARLI ISI BÜZÜŞMELİ KABLO EK MUFLARI

M.V. ALUMINUM THREE CORES HEAT SHRINKABLE CABLE JOINTS



3.5-6 kV

KOD CODE	KABLO KESİTİ CROSS SECTION	FİYAT PRICE
IBA6 325	3x25+16	3.430,00 ₺
IBA6 335	3x35+16	3.430,00 ₺
IBA6 350	3x50+16	3.445,00 ₺
IBA6 370	3x70+16	3.445,00 ₺
IBA6 395	3x95+16	3.445,00 ₺
IBA6 3120	3x120+16	3.450,00 ₺
IBA6 3150	3x150+25	3.450,00 ₺
IBA6 3185	3x185+25	3.450,00 ₺
IBA6 3240	3x240+25	3.485,00 ₺
IBA6 3300	3x300+25	3.625,00 ₺
IBA6 3400	3x400+35	3.715,00 ₺
IBA6 3500	3x500+35	3.970,00 ₺

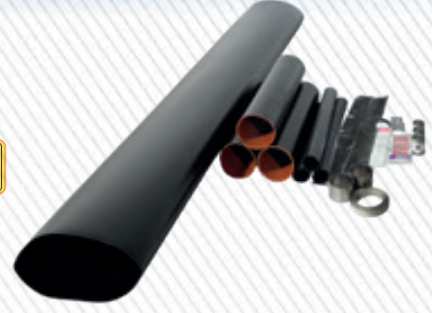

5.8-10 kV

KOD CODE	KABLO KESİTİ CROSS SECTION	FİYAT PRICE
IBA10 325	3x25+16	3.430,00 ₺
IBA10 335	3x35+16	3.430,00 ₺
IBA10 350	3x50+16	3.445,00 ₺
IBA10 370	3x70+16	3.445,00 ₺
IBA10 395	3x95+16	3.445,00 ₺
IBA10 3120	3x120+16	3.450,00 ₺
IBA10 3150	3x150+25	3.450,00 ₺
IBA10 3185	3x185+25	3.450,00 ₺
IBA10 3240	3x240+25	3.485,00 ₺
IBA10 3300	3x300+25	3.625,00 ₺
IBA10 3400	3x400+35	3.715,00 ₺
IBA10 3500	3x500+35	3.970,00 ₺



8.7-15 kV

KOD CODE	KABLO KESİTİ CROSS SECTION	FİYAT PRICE
IBA15 325	3x25+16	3.430,00 ₺
IBA15 335	3x35+16	3.430,00 ₺
IBA15 350	3x50+16	3.445,00 ₺
IBA15 370	3x70+16	3.445,00 ₺
IBA15 395	3x95+16	3.445,00 ₺
IBA15 3120	3x120+16	3.450,00 ₺
IBA15 3150	3x150+25	3.450,00 ₺
IBA15 3185	3x185+25	3.450,00 ₺
IBA15 3240	3x240+25	3.485,00 ₺
IBA15 3300	3x300+25	3.625,00 ₺
IBA15 3400	3x400+35	3.715,00 ₺
IBA15 3500	3x500+35	3.970,00 ₺



20.8-36 kV

KOD CODE	KABLO KESİTİ CROSS SECTION	FİYAT PRICE
IBA36 325	3x25+16	8.230,00 ₺
IBA36 335	3x35+16	8.230,00 ₺
IBA36 350	3x50+16	8.230,00 ₺
IBA36 370	3x70+16	8.235,00 ₺
IBA36 395	3x95+16	8.235,00 ₺
IBA36 3120	3x120+16	8.245,00 ₺
IBA36 3150	3x150+25	8.245,00 ₺
IBA36 3185	3x185+25	8.285,00 ₺
IBA36 3240	3x240+25	8.335,00 ₺
IBA36 3300	3x300+25	8.465,00 ₺
IBA36 3400	3x400+35	8.555,00 ₺
IBA36 3500	3x500+35	8.785,00 ₺

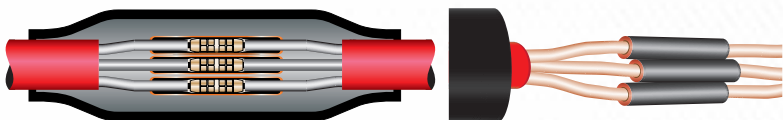



3.5-6 kV

5.8-10 kV

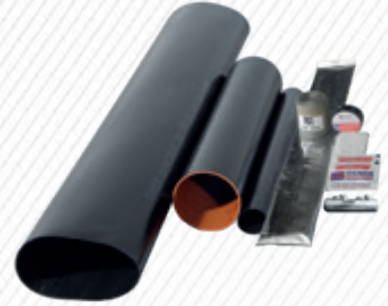

KOD CODE	KABLO KESİTİ CROSS SECTION	KOLİ ADETİ UNIT / BOX	FİYAT PRICE
MIB6 125-195	1x25+16 - 1x95+16	11	1.710,00 ₺
MIB6 1120-1300	1x120+16 - 1x300+25	11	1.830,00 ₺

KOD CODE	KABLO KESİTİ CROSS SECTION	KOLİ ADETİ UNIT / BOX	FİYAT PRICE
MIB10 125-195	1x25+16 - 1x95+16	11	1.710,00 ₺
MIB10 1120-1300	1x120+16 - 1x300+25	11	1.830,00 ₺

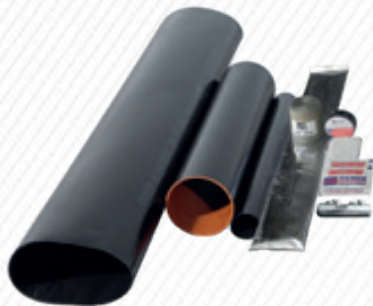
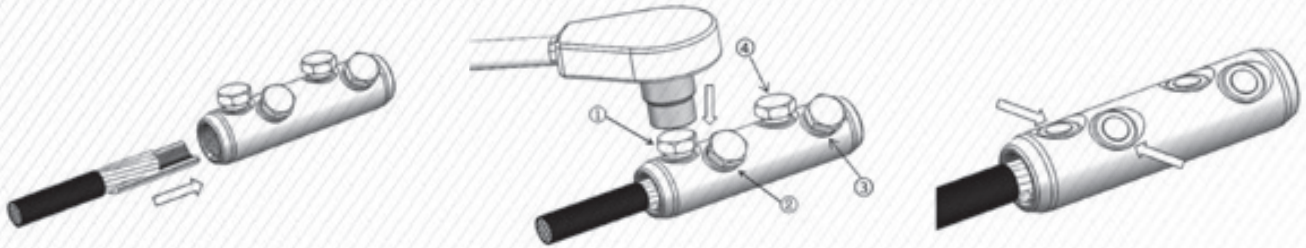

8.7-15 kV

20.8-36 kV



KOD CODE	KABLO KESİTİ CROSS SECTION	KOLİ ADETİ UNIT / BOX	FİYAT PRICE
MIB15 125-195	1x25+16 - 1x95+16	11	1.710,00 ₺
MIB15 1120-1300	1x120+16 - 1x300+25	11	1.830,00 ₺

KOD CODE	KABLO KESİTİ CROSS SECTION	KOLİ ADETİ UNIT / BOX	FİYAT PRICE
MIB36 135-170	1x35+16 - 1x70+16	11	2.220,00 ₺
MIB36 195-1150	1x95+16 - 1x150+16	11	2.285,00 ₺
MIB36 1185-1400	1x185+25 - 1x400+25	11	2.385,00 ₺
MIB36 1500-1630	1x1500+35 - 1x630+35	11	3.010,00 ₺

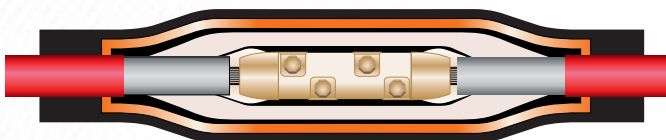

O.G. MEKANİK ÜÇ DAMARLI ISI BÜZÜŞMELİ KABLO EK MUFLARI

M.V. BOLTED THREE CORE HEAT SHRINKABLE CABLE JOINTS



3.5-6 kV

KOD CODE	KABLO KESİTİ CROSS SECTION	FİYAT PRICE
MIB6 325-395	3x25+16-3x95+16	4.940,00 ₺
MIB6 3120-3300	3x120+16-3x300+25	5.090,00 ₺

5.8-10 kV



KOD CODE	KABLO KESİTİ CROSS SECTION	FİYAT PRICE
MIB10 325-395	3x25+16-3x95+16	4.940,00 ₺
MIB10 3120-3300	3x120+16-3x300+25	5.090,00 ₺

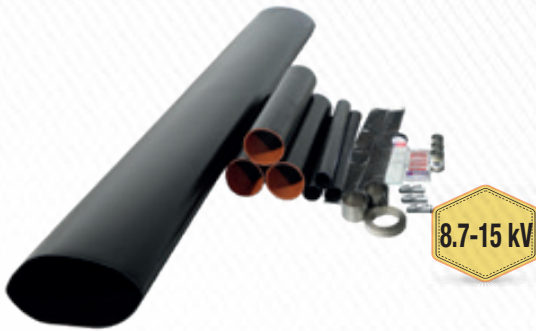
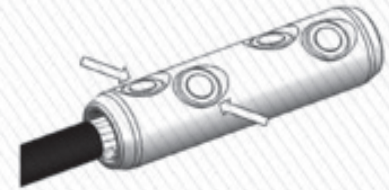
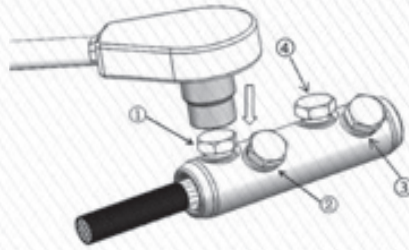
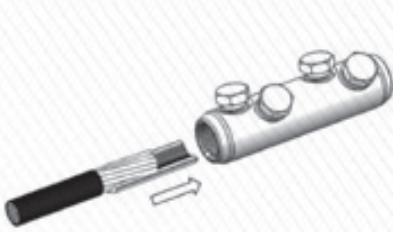

8.7-15 kV

KOD CODE	KABLO KESİTİ CROSS SECTION	FİYAT PRICE
MIB15 325-395	3x25+16-3x95+16	4.940,00 ₺
MIB15 3120-3300	3x120+16-3x300+25	5.090,00 ₺

20.8-36 kV



KOD CODE	KABLO KESİTİ CROSS SECTION	FİYAT PRICE
MIB36 335-370	3x35+16-3x70+16	9.410,00 ₺
MIB36 395-3150	3x95+16-3x150+25	9.485,00 ₺
MIB36 3185-3300	3x185+25-3x300+25	9.610,00 ₺
MIB36 3400-3500	3x400+35-3x500+35	10.590,00 ₺

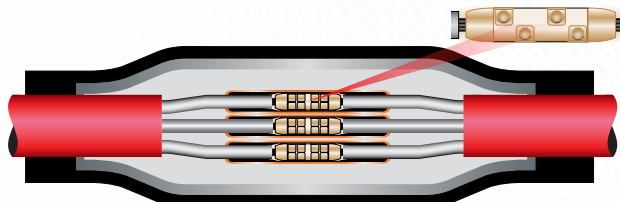



3.5-6 kV

5.8-10 kV

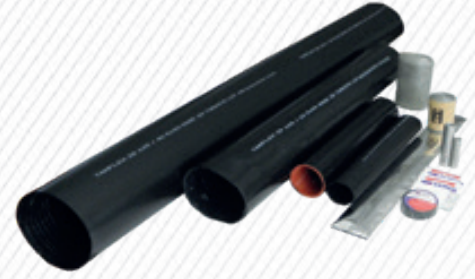

KOD CODE	KABLO KESİTİ CROSS SECTION	FİYAT PRICE
ZIB6 125	1x25+16	3.025,00 ₺
ZIB6 135	1x35+16	3.025,00 ₺
ZIB6 150	1x50+16	3.025,00 ₺
ZIB6 170	1x70+16	3.040,00 ₺
ZIB6 195	1x95+16	3.040,00 ₺
ZIB6 1120	1x120+16	3.060,00 ₺
ZIB6 1150	1x150+25	3.060,00 ₺
ZIB6 1185	1x185+25	3.085,00 ₺
ZIB6 1240	1x240+25	3.135,00 ₺
ZIB6 1300	1x300+25	3.230,00 ₺
ZIB6 1400	1x400+35	3.340,00 ₺
ZIB6 1500	1x500+35	3.610,00 ₺

KOD CODE	KABLO KESİTİ CROSS SECTION	FİYAT PRICE
ZIB10 125	1x25+16	3.025,00 ₺
ZIB10 135	1x35+16	3.025,00 ₺
ZIB10 150	1x50+16	3.025,00 ₺
ZIB10 170	1x70+16	3.040,00 ₺
ZIB10 195	1x95+16	3.040,00 ₺
ZIB10 1120	1x120+16	3.060,00 ₺
ZIB10 1150	1x150+25	3.060,00 ₺
ZIB10 1185	1x185+25	3.085,00 ₺
ZIB10 1240	1x240+25	3.135,00 ₺
ZIB10 1300	1x300+25	3.230,00 ₺
ZIB10 1400	1x400+35	3.340,00 ₺
ZIB10 1500	1x500+35	3.610,00 ₺



8.7-15 kV

20.8-36 kV



KOD CODE	KABLO KESİTİ CROSS SECTION	FİYAT PRICE
ZIB15 125	1x25+16	3.025,00 ₺
ZIB15 135	1x35+16	3.025,00 ₺
ZIB15 150	1x50+16	3.025,00 ₺
ZIB15 170	1x70+16	3.040,00 ₺
ZIB15 195	1x95+16	3.040,00 ₺
ZIB15 1120	1x120+16	3.060,00 ₺
ZIB15 1150	1x150+25	3.060,00 ₺
ZIB15 1185	1x185+25	3.085,00 ₺
ZIB15 1240	1x240+25	3.135,00 ₺
ZIB15 1300	1x300+25	3.230,00 ₺
ZIB15 1400	1x400+35	3.340,00 ₺
ZIB15 1500	1x500+35	3.610,00 ₺

KOD CODE	KABLO KESİTİ CROSS SECTION	FİYAT PRICE
ZIB36 125	1x25+16	4.260,00 ₺
ZIB36 135	1x35+16	4.260,00 ₺
ZIB36 150	1x50+16	4.280,00 ₺
ZIB36 170	1x70+16	4.280,00 ₺
ZIB36 195	1x95+16	4.280,00 ₺
ZIB36 1120	1x120+16	4.295,00 ₺
ZIB36 1150	1x150+25	4.295,00 ₺
ZIB36 1185	1x185+25	4.325,00 ₺
ZIB36 1240	1x240+25	4.390,00 ₺
ZIB36 1300	1x300+25	4.535,00 ₺
ZIB36 1400	1x400+35	4.615,00 ₺
ZIB36 1500	1x500+35	4.950,00 ₺

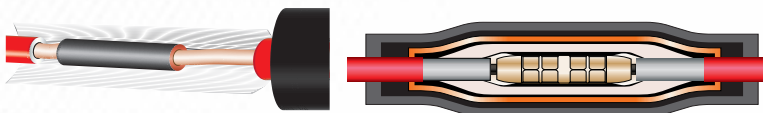

O.G. ZIRHLI BAKIR ÜÇ DAMARLI ISI BÜZÜŞMELİ KABLO EK MUFLARI

M.V. ARMoured COPPER THREE CORES HEAT SHRINKABLE CABLE JOINTS

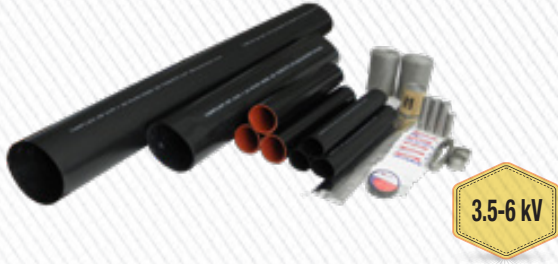

3.5-6 kV

5.8-10 kV



KOD CODE	KABLO KESİTİ CROSS SECTION	FİYAT PRICE
ZIB6 325	3x25+16	5.640,00 ₺
ZIB6 335	3x35+16	5.640,00 ₺
ZIB6 350	3x50+16	5.655,00 ₺
ZIB6 370	3x70+16	5.655,00 ₺
ZIB6 395	3x95+16	5.655,00 ₺
ZIB6 3120	3x120+16	5.670,00 ₺
ZIB6 3150	3x150+25	5.670,00 ₺
ZIB6 3185	3x185+25	5.670,00 ₺
ZIB6 3240	3x240+25	5.710,00 ₺
ZIB6 3300	3x300+25	5.900,00 ₺
ZIB6 3400	3x400+35	6.000,00 ₺
ZIB6 3500	3x500+35	6.295,00 ₺

KOD CODE	KABLO KESİTİ CROSS SECTION	FİYAT PRICE
ZIB10 325	3x25+16	5.640,00 ₺
ZIB10 335	3x35+16	5.640,00 ₺
ZIB10 350	3x50+16	5.655,00 ₺
ZIB10 370	3x70+16	5.655,00 ₺
ZIB10 395	3x95+16	5.655,00 ₺
ZIB10 3120	3x120+16	5.670,00 ₺
ZIB10 3150	3x150+25	5.670,00 ₺
ZIB10 3185	3x185+25	5.670,00 ₺
ZIB10 3240	3x240+25	5.710,00 ₺
ZIB10 3300	3x300+25	5.900,00 ₺
ZIB10 3400	3x400+35	6.000,00 ₺
ZIB10 3500	3x500+35	6.295,00 ₺



8.7-15 kV

20.8-36 kV



KOD CODE	KABLO KESİTİ CROSS SECTION	FİYAT PRICE
ZIB15 325	3x25+16	5.640,00 ₺
ZIB15 335	3x35+16	5.640,00 ₺
ZIB15 350	3x50+16	5.655,00 ₺
ZIB15 370	3x70+16	5.655,00 ₺
ZIB15 395	3x95+16	5.655,00 ₺
ZIB15 3120	3x120+16	5.670,00 ₺
ZIB15 3150	3x150+25	5.670,00 ₺
ZIB15 3185	3x185+25	5.670,00 ₺
ZIB15 3240	3x240+25	5.710,00 ₺
ZIB15 3300	3x300+25	5.900,00 ₺
ZIB15 3400	3x400+35	6.000,00 ₺
ZIB15 3500	3x500+35	6.295,00 ₺

KOD CODE	KABLO KESİTİ CROSS SECTION	FİYAT PRICE
ZIB36 325	3x25+16	12.960,00 ₺
ZIB36 335	3x35+16	12.960,00 ₺
ZIB36 350	3x50+16	12.960,00 ₺
ZIB36 370	3x70+16	12.970,00 ₺
ZIB36 395	3x95+16	12.970,00 ₺
ZIB36 3120	3x120+16	12.980,00 ₺
ZIB36 3150	3x150+25	12.980,00 ₺
ZIB36 3185	3x185+25	12.990,00 ₺
ZIB36 3240	3x240+25	13.065,00 ₺
ZIB36 3300	3x300+25	13.295,00 ₺
ZIB36 3400	3x400+35	13.410,00 ₺
ZIB36 3500	3x500+35	13.695,00 ₺



Isı Büzüşmeli
Ek Muflar



3.5-6 kV

5.8-10 kV

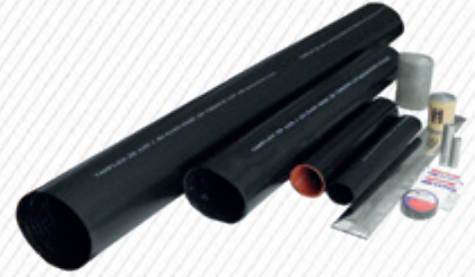

KOD CODE	KABLO KESİTİ CROSS SECTION	FİYAT PRICE
ZIBA6 125	1x25+16	3.015,00 ₺
ZIBA6 135	1x35+16	3.015,00 ₺
ZIBA6 150	1x50+16	3.015,00 ₺
ZIBA6 170	1x70+16	3.030,00 ₺
ZIBA6 195	1x95+16	3.030,00 ₺
ZIBA6 1120	1x120+16	3.050,00 ₺
ZIBA6 1150	1x150+25	3.050,00 ₺
ZIBA6 1185	1x185+25	3.075,00 ₺
ZIBA6 1240	1x240+25	3.125,00 ₺
ZIBA6 1300	1x300+25	3.220,00 ₺
ZIBA6 1400	1x400+35	3.330,00 ₺
ZIBA6 1500	1x500+35	3.600,00 ₺

KOD CODE	KABLO KESİTİ CROSS SECTION	FİYAT PRICE
ZIBA10 125	1x25+16	3.015,00 ₺
ZIBA10 135	1x35+16	3.015,00 ₺
ZIBA10 150	1x50+16	3.015,00 ₺
ZIBA10 170	1x70+16	3.030,00 ₺
ZIBA10 195	1x95+16	3.030,00 ₺
ZIBA10 1120	1x120+16	3.050,00 ₺
ZIBA10 1150	1x150+25	3.050,00 ₺
ZIBA10 1185	1x185+25	3.075,00 ₺
ZIBA10 1240	1x240+25	3.125,00 ₺
ZIBA10 1300	1x300+25	3.220,00 ₺
ZIBA10 1400	1x400+35	3.330,00 ₺
ZIBA10 1500	1x500+35	3.600,00 ₺



8.7-15 kV

20.8-36 kV



KOD CODE	KABLO KESİTİ CROSS SECTION	FİYAT PRICE
ZIBA15 125	1x25+16	3.015,00 ₺
ZIBA15 135	1x35+16	3.015,00 ₺
ZIBA15 150	1x50+16	3.015,00 ₺
ZIBA15 170	1x70+16	3.030,00 ₺
ZIBA15 195	1x95+16	3.030,00 ₺
ZIBA15 1120	1x120+16	3.050,00 ₺
ZIBA15 1150	1x150+25	3.050,00 ₺
ZIBA15 1185	1x185+25	3.075,00 ₺
ZIBA15 1240	1x240+25	3.125,00 ₺
ZIBA15 1300	1x300+25	3.220,00 ₺
ZIBA15 1400	1x400+35	3.330,00 ₺
ZIBA15 1500	1x500+35	3.600,00 ₺

KOD CODE	KABLO KESİTİ CROSS SECTION	FİYAT PRICE
ZIBA36 125	1x25+16	4.250,00 ₺
ZIBA36 135	1x35+16	4.250,00 ₺
ZIBA36 150	1x50+16	4.270,00 ₺
ZIBA36 170	1x70+16	4.270,00 ₺
ZIBA36 195	1x95+16	4.270,00 ₺
ZIBA36 1120	1x120+16	4.285,00 ₺
ZIBA36 1150	1x150+25	4.285,00 ₺
ZIBA36 1185	1x185+25	4.315,00 ₺
ZIBA36 1240	1x240+25	4.380,00 ₺
ZIBA36 1300	1x300+25	4.525,00 ₺
ZIBA36 1400	1x400+35	4.605,00 ₺
ZIBA36 1500	1x500+35	4.940,00 ₺

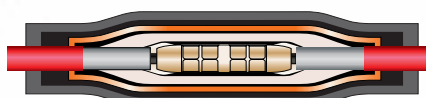
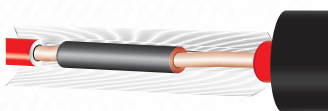

O.G. ZIRHLI ALÜMİNYUM ÜÇ DAMARLI ISI BÜZÜŞMELİ KABLO EK MUFLARI

M.V. ARMoured ALUMINUM THREE CORES HEAT SHRINKABLE CABLE JOINTS



3.5-6 kV

5.8-10 kV



KOD CODE	KABLO KESİTİ CROSS SECTION	FİYAT PRICE
ZIBA6 325	3x25+16	5.630,00 ₺
ZIBA6 335	3x35+16	5.630,00 ₺
ZIBA6 350	3x50+16	5.645,00 ₺
ZIBA6 370	3x70+16	5.645,00 ₺
ZIBA6 395	3x95+16	5.645,00 ₺
ZIBA6 3120	3x120+16	5.660,00 ₺
ZIBA6 3150	3x150+25	5.660,00 ₺
ZIBA6 3185	3x185+25	5.660,00 ₺
ZIBA6 3240	3x240+25	5.700,00 ₺
ZIBA6 3300	3x300+25	5.890,00 ₺
ZIBA6 3400	3x400+35	5.990,00 ₺
ZIBA6 3500	3x500+35	6.285,00 ₺

KOD CODE	KABLO KESİTİ CROSS SECTION	FİYAT PRICE
ZIBA10 325	3x25+16	5.630,00 ₺
ZIBA10 335	3x35+16	5.630,00 ₺
ZIBA10 350	3x50+16	5.645,00 ₺
ZIBA10 370	3x70+16	5.645,00 ₺
ZIBA10 395	3x95+16	5.645,00 ₺
ZIBA10 3120	3x120+16	5.660,00 ₺
ZIBA10 3150	3x150+25	5.660,00 ₺
ZIBA10 3185	3x185+25	5.660,00 ₺
ZIBA10 3240	3x240+25	5.700,00 ₺
ZIBA10 3300	3x300+25	5.890,00 ₺
ZIBA10 3400	3x400+35	5.990,00 ₺
ZIBA10 3500	3x500+35	6.285,00 ₺



8.7-15 kV

20.8-36 kV



KOD CODE	KABLO KESİTİ CROSS SECTION	FİYAT PRICE
ZIBA15 325	3x25+16	5.630,00 ₺
ZIBA15 335	3x35+16	5.630,00 ₺
ZIBA15 350	3x50+16	5.645,00 ₺
ZIBA15 370	3x70+16	5.645,00 ₺
ZIBA15 395	3x95+16	5.645,00 ₺
ZIBA15 3120	3x120+16	5.660,00 ₺
ZIBA15 3150	3x150+25	5.660,00 ₺
ZIBA15 3185	3x185+25	5.660,00 ₺
ZIBA15 3240	3x240+25	5.700,00 ₺
ZIBA15 3300	3x300+25	5.890,00 ₺
ZIBA15 3400	3x400+35	5.990,00 ₺
ZIBA15 3500	3x500+35	6.285,00 ₺

KOD CODE	KABLO KESİTİ CROSS SECTION	FİYAT PRICE
ZIBA36 325	3x25+16	12.950,00 ₺
ZIBA36 335	3x35+16	12.950,00 ₺
ZIBA36 350	3x50+16	12.950,00 ₺
ZIBA36 370	3x70+16	12.960,00 ₺
ZIBA36 395	3x95+16	12.960,00 ₺
ZIBA36 3120	3x120+16	12.970,00 ₺
ZIBA36 3150	3x150+25	12.970,00 ₺
ZIBA36 3185	3x185+25	12.980,00 ₺
ZIBA36 3240	3x240+25	13.055,00 ₺
ZIBA36 3300	3x300+25	13.285,00 ₺
ZIBA36 3400	3x400+35	13.400,00 ₺
ZIBA36 3500	3x500+35	13.685,00 ₺



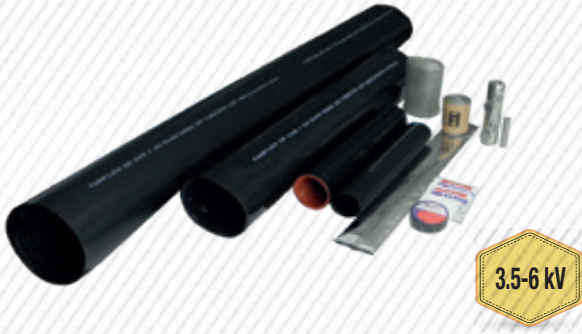

3.5-6 kV

KOD CODE	KABLO KESİTİ CROSS SECTION	FİYAT PRICE
MZIB6 125-195	1x25+16 - 1x95+16	3.315,00 ₺
MZIB6 1120-1300	1x120+16 - 1x300+25	3.540,00 ₺

5.8-10 kV

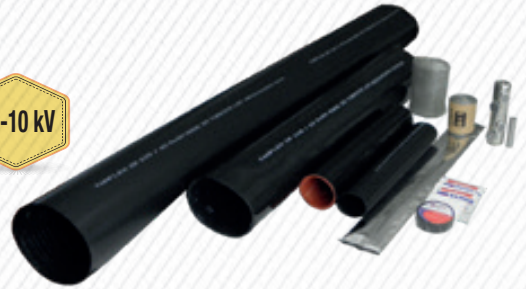

KOD CODE	KABLO KESİTİ CROSS SECTION	FİYAT PRICE
MZIB10 125-195	1x25+16 - 1x95+16	3.315,00 ₺
MZIB10 1120-1300	1x120+16 - 1x300+25	3.540,00 ₺

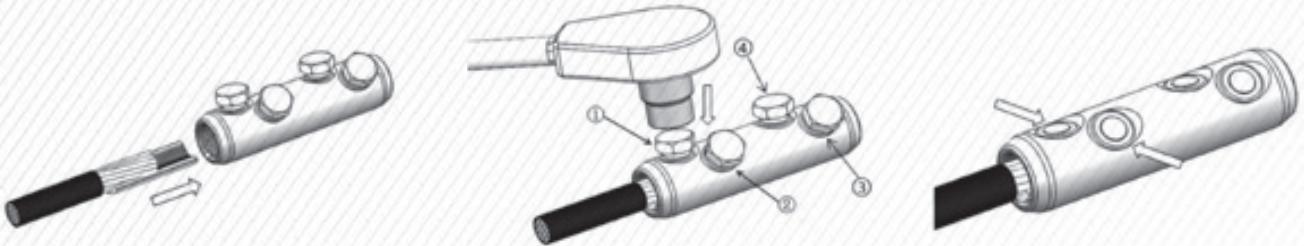

8.7-15 kV

KOD CODE	KABLO KESİTİ CROSS SECTION	FİYAT PRICE
MZIB15 125-195	1x25+16 - 1x95+16	3.315,00 ₺
MZIB15 1120-1300	1x120+16 - 1x300+25	3.540,00 ₺

20.8-36 kV

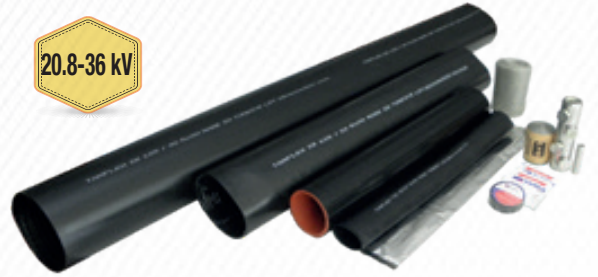

KOD CODE	KABLO KESİTİ CROSS SECTION	FİYAT PRICE
MZIB36 135-170	1x35+16 - 1x70+16	4.570,00 ₺
MZIB36 195-1150	1x95+16 - 1x150+16	4.660,00 ₺
MZIB36 1185-1300	1x185+25 - 1x400+25	4.795,00 ₺
MZIB36 1400-1630	1x1500+35 - 1x630+35	5.020,00 ₺

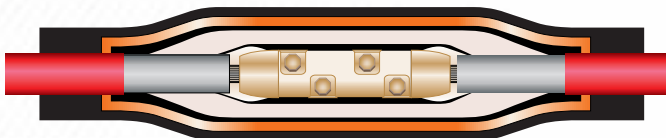

O.G. ZIRHLI MEKANİK ÜÇ DAMARLI ISI BÜZÜŞMELİ KABLO EK MUFLARI

M.V. ARMoured BOLTED THREE CORES HEAT SHRINKABLE CABLE JOINTS

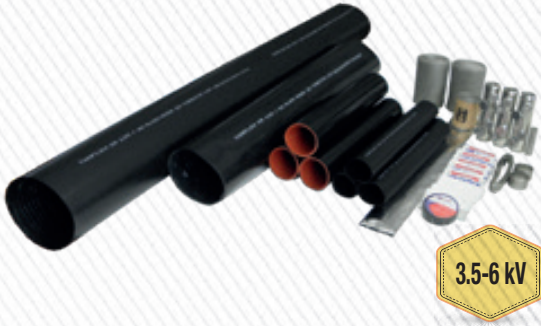

3.5-6 kV

5.8-10 kV



KOD CODE	KABLO KESİTİ CROSS SECTION	FİYAT PRICE
MZIB6 325-395	3x25+16 - 3x95+16	6.050,00 ₺
MZIB6 3120-3300	3x120+16 - 3x300+25	6.360,00 ₺

KOD CODE	KABLO KESİTİ CROSS SECTION	FİYAT PRICE
MZIB10 325-395	3x25+16 - 3x95+16	6.050,00 ₺
MZIB10 3120-3300	3x120+16 - 3x300+25	6.360,00 ₺

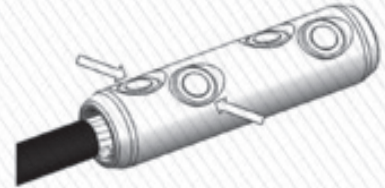
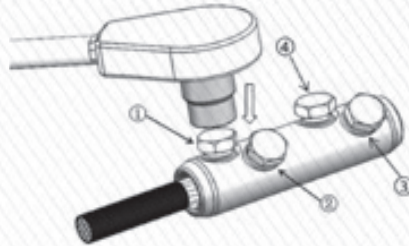
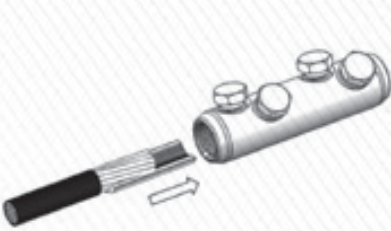

8.7-15 kV

20.8-36 kV



KOD CODE	KABLO KESİTİ CROSS SECTION	FİYAT PRICE
MZIB15 325-395	3x25+16 - 3x95+16	6.050,00 ₺
MZIB15 3120-3300	3x120+16 - 3x300+25	6.360,00 ₺

KOD CODE	KABLO KESİTİ CROSS SECTION	FİYAT PRICE
MZIB36 335-370	3x35+16 - 3x70+16	13.375,00 ₺
MZIB36 395-3150	3x95+16 - 3x150+25	13.440,00 ₺
MZIB36 3185-3300	3x185+25 - 3x300+25	13.600,00 ₺
MZIB36 3400-3500	3x400+35 - 3x500+35	13.890,00 ₺

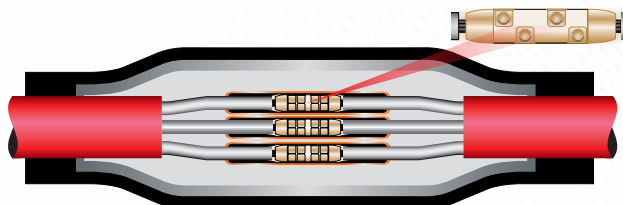



PAPUÇSUZ

0.6-1 kV

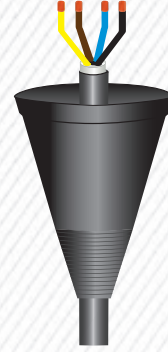

KOD CODE	KABLO KESİTİ CROSS SECTION	KOLİ ADETİ UNIT / BOX	FİYAT PRICE
PKB 01	2x1,5 - 3x50+25	50	70,00 ₺



0.6-1 kV



KOD CODE	KABLO KESİTİ CROSS SECTION	KOLİ ADETİ UNIT / BOX	FİYAT PRICE
PKB 02	3x70+35 - 3x95+50	50	99,00 ₺



0.6-1 kV

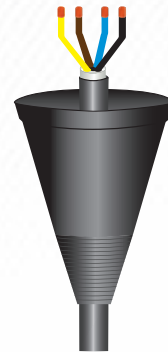

KOD CODE	KABLO KESİTİ CROSS SECTION	KOLİ ADETİ UNIT / BOX	FİYAT PRICE
PKB 03	3x120+70 - 3x150+70	32	168,00 ₺

A.G. PABUÇLU REÇİNELİ KABLO BAŞLIKLARI

L. V. WITH LUG RESIN CABLE TERMINATIONS

PAPUÇLU

KOD CODE	KABLO KESİTİ CROSS SECTION	KOLİ ADETİ UNIT / BOX	FIYAT PRICE
B1 504 - B1 506	5x4 - 5x6	50	263,00 ₺
B1 510	5x10	50	267,00 ₺
B1 516	5x16	50	269,00 ₺
B1 4105 - B1 4205	4x1,5 - 4x2,5	50	260,00 ₺
B1 404 - B1 406	4x4 - 4x6	50	260,00 ₺
B1 410	4x10	50	263,00 ₺
B1 416	4x16	50	272,00 ₺
B1 31610	3x16+10	50	267,00 ₺



0.6-1 kV

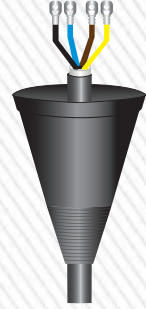

KOD CODE	KABLO KESİTİ CROSS SECTION	KOLİ ADETİ UNIT / BOX	FIYAT PRICE
B1 32516	3x25+16	50	297,00 ₺
B1 33516	3x35+16	50	318,00 ₺
B1 35025	3x50+25	50	345,00 ₺
B1 37035	3x70+35	50	393,00 ₺
B1 39550	3x95+50	50	414,00 ₺



0.6-1 kV



KOD CODE	KABLO KESİTİ CROSS SECTION	KOLİ ADETİ UNIT / BOX	FIYAT PRICE
B1 31207	3x120+70	32	472,00 ₺
B1 31507	3x150+70	32	496,00 ₺
B1 31859	3x185+95	32	590,00 ₺
B1 32401	3x240+120	32	653,00 ₺



0.6-1 kV



AG Kablo
Başlıkları

* Alüminyum iletkenli üretim yapılır. / * Production of aluminium conductors are made

PAPUÇLU

0.6-1 kV

KOD CODE	KABLO KESİTİ CROSS SECTION	KOLİ ADETİ UNIT / BOX	FİYAT PRICE
B1 315 - B1 304	3x1,5 - 3x4	50	254,00 ₺
B1 306 - B1 310	3x6 - 3x10	50	258,00 ₺
B1 316 - B1 325	3x16 - 3x25	50	267,00 ₺
B1 335 - B1 350	3x35 - 3x50	50	338,00 ₺
B1 370 - B1 395	3x70 - 3x95	50	405,00 ₺
B1 3120 - B1 3150	3x120 - 3x150	32	465,00 ₺
B1 3185	3x185	32	583,00 ₺
B1 3240	3x240	32	644,00 ₺



0.6-1 kV

KOD CODE	KABLO KESİTİ CROSS SECTION	KOLİ ADETİ UNIT / BOX	FİYAT PRICE
B1 215 - B1 204	2x1,5 - 2x4	50	235,00 ₺
B1 206 - B1 210	2 x6 - 2x10	50	238,00 ₺
B1 216 - B1 225	2x16 - 2x2 5	50	260,00 ₺
B1 235 - B1 250	2x35 - 2x50	50	381,00 ₺
B1 270 - B1 295	2x70 - 2x95	50	386,00 ₺
B1 2120 - B1 2150	2x120 - 2x150	32	460,00 ₺
B1 2185	2x185	32	577,00 ₺
B1 2240	2x240	32	602,00 ₺



0.6-1 kV

KOD CODE	KABLO KESİTİ CROSS SECTION	KOLİ ADETİ UNIT / BOX	FİYAT PRICE
B1 115 - B1 104	1 x1,5 - 1 x4	50	146,00 ₺
B1 106 - B1 110	1x6 - 1x10	50	160,00 ₺
B1 116 - B1 125	1x16 - 1x2 5	50	173,00 ₺
B1 135 - B1 150	1x35 - 1x50	50	190,00 ₺
B1 170 - B1 195	1x70 - 1x95	50	212,00 ₺
B1 1120 - B1 1150	1x120 - 1x150	32	254,00 ₺
B1 1185	1x185	32	278,00 ₺
B1 1240	1x240	32	286,00 ₺



36 KV

OG

Isı
Büzüşmeli
Kablo
Başlıkları



BAKIR İLETKENLER İÇİN

FOR COPPER TERMINATIONS

0.6-1 kV



KOD CODE	KABLO KESİTİ CROSS SECTION	FİYAT PRICE
IBB1 1205	1x2,5	8,70 ₺
IBB1 104	1x4	8,70 ₺
IBB1 106	1x6	8,70 ₺
IBB1 110	1x10	10,10 ₺
IBB1 116	1x16	14,00 ₺
IBB1 125	1x25	17,00 ₺
IBB1 135	1x35	25,00 ₺
IBB1 150	1x50	35,00 ₺
IBB1 170	1x70	45,00 ₺
IBB1 195	1x95	56,00 ₺
IBB1 1120	1x120	75,00 ₺
IBB1 1150	1x150	96,00 ₺
IBB1 1185	1x185	109,00 ₺
IBB1 1240	1x240	161,00 ₺
IBB1 1300	1x300	215,00 ₺
IBB1 1400	1x400	252,00 ₺

ALÜMİNYUM İLETKENLER İÇİN

FOR ALUMINUM TERMINATIONS

0.6-1 kV



KOD CODE	KABLO KESİTİ CROSS SECTION	FİYAT PRICE
AIBB1 110	1x10	9,00 ₺
AIBB1 116	1x16	9,00 ₺
AIBB1 125	1x25	13,00 ₺
AIBB1 135	1x35	19,00 ₺
AIBB1 150	1x50	22,50 ₺
AIBB1 170	1x70	31,50 ₺
AIBB1 195	1x95	45,00 ₺
AIBB1 1120	1x120	71,00 ₺
AIBB1 1150	1x150	82,00 ₺
AIBB1 1185	1x185	90,00 ₺
AIBB1 1240	1x240	115,00 ₺
AIBB1 1300	1x300	140,00 ₺
AIBB1 1400	1x400	200,00 ₺

AG TEK DAMARLI ISI BÜZÜŞMELİ KABLO BAŞLIKLARI

L.V. SINGLE CORE HEAT SHRINKABLE CABLE TERMINATIONS

MEKANİK İLETKENLER İÇİN

FOR MECHANIC TERMINATIONS



KOD CODE	KABLO KESİTİ CROSS SECTION	FİYAT PRICE
MIBB1 125-195	1x25-1x95	\$26,50
MIBB1 1120-1150	1x120-1x150	\$29,50
MIBB1 1185-1240	1x185-1x240	\$40,50

BİMETAL İLETKENLER İÇİN

FOR BIMETALLIC TERMINATIONS



KOD CODE	KABLO KESİTİ CROSS SECTION	FİYAT PRICE
BIBB1 110	1x10	\$4,85
BIBB1 116	1x16	\$4,85
BIBB1 125	1x25	\$4,85
BIBB1 135	1x35	\$4,95
BIBB1 150	1x50	\$5,90
BIBB1 170	1x70	\$6,00
BIBB1 195	1x95	\$6,00
BIBB1 1120	1x120	\$10,25
BIBB1 1150	1x150	\$10,25
BIBB1 1185	1x185	\$15,85
BIBB1 1240	1x240	\$15,85



PAPUÇLU



0.6-1 kV

KOD CODE	KABLO KESİTİ CROSS SECTION	FİYAT PRICE
-------------	-------------------------------	----------------

4 DAMARLI PABUÇLU KABLO BAŞLIĞI

IBB1 4205	4x2,5	280,00 ₺
IBB1 404	4x4	280,00 ₺
IBB1 406	4x6	280,00 ₺
IBB1 410	4x10	285,00 ₺
IBB1 416	4x16	295,00 ₺
IBB1 425	4x25	330,00 ₺
IBB1 435	4x35	353,00 ₺
IBB1 450	4x50	385,00 ₺
IBB1 470	4x70	435,00 ₺
IBB1 495	4x95	470,00 ₺
IBB1 4120	4x120	545,00 ₺
IBB1 4150	4x150	570,00 ₺
IBB1 4185	4x185	672,00 ₺
IBB1 4240	4x240	740,00 ₺
IBB1 4300	4x300	965,00 ₺
IBB1 4400	4x400	999,00 ₺
IBB1 31610	3x16+10	292,00 ₺
IBB1 32516	3x25+16	292,00 ₺
IBB1 33516	3x35+16	350,00 ₺
IBB1 35025	3x50+25	380,00 ₺
IBB1 37035	3x70+35	430,00 ₺
IBB1 39550	3x95+50	465,00 ₺
IBB1 31207	3x120+70	530,00 ₺
IBB1 31507	3x150+70	555,00 ₺
IBB1 31859	3x185+95	657,00 ₺
IBB1 32401	3x240+120	725,00 ₺
IBB1 33001	3x300+150	950,00 ₺
IBB1 34001	3x400+185	985,00 ₺

KOD CODE	KABLO KESİTİ CROSS SECTION	FİYAT PRICE
-------------	-------------------------------	----------------

2 DAMARLI PABUÇLU KABLO BAŞLIĞI

IBB1 2205	2x2,5	255,00 ₺
IBB1 204	2x4	255,00 ₺
IBB1 206	2x6	255,00 ₺
IBB1 210	2x10	270,00 ₺
IBB1 216	2x16	270,00 ₺
IBB1 225	2x25	305,00 ₺
IBB1 235	2x35	315,00 ₺
IBB1 250	2x50	410,00 ₺
IBB1 270	2x70	410,00 ₺
IBB1 295	2x95	430,00 ₺
IBB1 2120	2x120	500,00 ₺
IBB1 2150	2x150	515,00 ₺
IBB1 2185	2x185	610,00 ₺

KOD CODE	KABLO KESİTİ CROSS SECTION	FİYAT PRICE
-------------	-------------------------------	----------------

5 DAMARLI PABUÇLU KABLO BAŞLIĞI

IBB1 5205	5 x2,5	325,00 ₺
IBB1 504	5 x4	325,00 ₺
IBB1 506	5 x6	325,00 ₺
IBB1 510	5 x10	375,00 ₺
IBB1 516	5 x16	390,00 ₺
IBB1 525	5 x25	430,00 ₺
IBB1 535	5 x35	450,00 ₺
IBB1 550	5 x50	495,00 ₺
IBB1 570	5 x70	570,00 ₺
IBB1 595	5 x95	599,00 ₺
IBB1 5120	5 x120	685,00 ₺
IBB1 5150	5 x150	715,00 ₺
IBB1 5185	5 x185	850,00 ₺



* Alüminyum iletkenli üretim yapılır. / * Production of aluminium conductors are made

AG BAKIR İLETKENLİ ÇOK DAMARLI ISI BÜZÜŞMELİ KABLO BAŞLIKLARI

L.V. MULTI CORE HEAT SHRINKABLE CABLE TERMINATIONS FOR COPPER CABLE



0.6-1 KV

KOD CODE	KABLO KESİTİ CROSS SECTION	FİYAT PRICE
-------------	-------------------------------	----------------

4 DAMARLI PABUÇSUZ KABLO BAŞLIĞI

IBBX 1 4205	4x2,5	190,00 ₺
IBBX 1 404	4x4	190,00 ₺
IBBX 1 406	4x6	190,00 ₺
IBBX 1 410	4x10	190,00 ₺
IBBX 1 416	4x16	190,00 ₺
IBBX 1 425	4x25	190,00 ₺
IBBX 1 435	4x35	305,00 ₺
IBBX 1 450	4x50	305,00 ₺
IBBX 1 470	4x70	305,00 ₺
IBBX 1 495	4x95	305,00 ₺
IBBX 1 4120	4x120	380,00 ₺
IBBX 1 4150	4x150	380,00 ₺
IBBX 1 4185	4x185	380,00 ₺
IBBX 1 4240	4x240	455,00 ₺
IBBX1 4300	4x300	455,00 ₺
IBBX1 4400	4x400	455,00 ₺
IBBX1 31610	3x16+10	190,00 ₺
IBBX1 32516	3x25+16	190,00 ₺
IBBX1 33516	3x35+16	305,00 ₺
IBBX1 35025	3x50+25	305,00 ₺
IBBX1 37035	3x70+35	305,00 ₺
IBBX1 39550	3x95+50	305,00 ₺
IBBX1 31207	3x120+70	380,00 ₺
IBBX1 31507	3x150+70	380,00 ₺
IBBX1 31859	3x185+95	380,00 ₺
IBBX1 32401	3x240+120	455,00 ₺
IBBX1 33001	3x300+150	455,00 ₺
IBBX1 34001	3x400+185	455,00 ₺

KOD CODE	KABLO KESİTİ CROSS SECTION	FİYAT PRICE
-------------	-------------------------------	----------------

2 DAMARLI PABUÇSUZ KABLO BAŞLIĞI

IBBX 1 2205	2x2,5	160,00 ₺
IBBX 1 204	2x4	160,00 ₺
IBBX 1 206	2x6	160,00 ₺
IBBX 1 210	2x10	160,00 ₺
IBBX 1 216	2x16	160,00 ₺
IBBX 1 225	2x25	160,00 ₺
IBBX 1 235	2x35	280,00 ₺
IBBX 1 250	2x50	280,00 ₺
IBBX 1 270	2x70	280,00 ₺
IBBX 1 295	2x95	280,00 ₺
IBBX 1 2120	2x120	350,00 ₺
IBBX 1 2150	2x150	350,00 ₺
IBBX 1 2185	2x185	350,00 ₺

KOD CODE	KABLO KESİTİ CROSS SECTION	FİYAT PRICE
-------------	-------------------------------	----------------

5 DAMARLI PABUÇSUZ KABLO BAŞLIĞI

IBBX1 5205	5 x2,5	240,00 ₺
IBBX1 504	5 x4	240,00 ₺
IBBX1 506	5 x6	240,00 ₺
IBBX1 510	5 x10	240,00 ₺
IBBX1 516	5 x16	240,00 ₺
IBBX1 525	5 x25	240,00 ₺
IBBX1 535	5 x35	400,00 ₺
IBBX1 550	5 x50	400,00 ₺
IBBX1 570	5 x70	400,00 ₺
IBBX1 595	5 x95	400,00 ₺
IBBX1 5120	5 x120	485,00 ₺
IBBX1 5150	5 x150	485,00 ₺
IBBX1 5185	5 x185	485,00 ₺



* Alüminyum iletkenli üretim yapılır. / * Production of aluminium conductors are made



0.6-1 kV

KOD CODE	KABLO KESİTİ CROSS SECTION	FİYAT PRICE
4 DAMARLI PABUÇLU KABLO BAŞLIĞI		
AIBB1 4205	4x2,5	275,00 ₺
AIBB1 404	4x4	275,00 ₺
AIBB1 406	4x6	275,00 ₺
AIBB1 410	4x10	280,00 ₺
AIBB1 416	4x16	290,00 ₺
AIBB1 425	4x25	325,00 ₺
AIBB1 435	4x35	348,00 ₺
AIBB1 450	4x50	380,00 ₺
AIBB1 470	4x70	430,00 ₺
AIBB1 495	4x95	465,00 ₺
AIBB1 4120	4x120	540,00 ₺
AIBB1 4150	4x150	565,00 ₺
AIBB1 4185	4x185	667,00 ₺
AIBB1 4240	4x240	735,00 ₺
AIBB1 4300	4x300	960,00 ₺
AIBB1 4400	4x400	994,00 ₺
AIBB1 31610	3x16+10	287,00 ₺
AIBB1 32516	3x25+16	287,00 ₺
AIBB1 33516	3x35+16	345,00 ₺
AIBB1 35025	3x50+25	375,00 ₺
AIBB1 37035	3x70+35	425,00 ₺
AIBB1 39550	3x95+50	460,00 ₺
AIBB1 31207	3x120+70	525,00 ₺
AIBB1 31507	3x150+70	550,00 ₺
AIBB1 31859	3x185+95	652,00 ₺
AIBB1 32401	3x240+120	720,00 ₺
AIBB1 33001	3x300+150	945,00 ₺
AIBB1 34001	3x400+185	980,00 ₺

KOD CODE	KABLO KESİTİ CROSS SECTION	FİYAT PRICE
2 DAMARLI PABUÇLU KABLO BAŞLIĞI		
AIBB1 2205	2x2,5	250,00 ₺
AIBB1 204	2x4	250,00 ₺
AIBB1 206	2x6	250,00 ₺
AIBB1 210	2x10	265,00 ₺
AIBB1 216	2x16	265,00 ₺
AIBB1 225	2x25	300,00 ₺
AIBB1 235	2x35	310,00 ₺
AIBB1 250	2x50	405,00 ₺
AIBB1 270	2x70	405,00 ₺
AIBB1 295	2x95	425,00 ₺
AIBB1 2120	2x120	495,00 ₺
AIBB1 2150	2x150	510,00 ₺
AIBB1 2185	2x185	605,00 ₺

KOD CODE	KABLO KESİTİ CROSS SECTION	FİYAT PRICE
5 DAMARLI PABUÇLU KABLO BAŞLIĞI		
AIBB1 5205	5 x2,5	320,00 ₺
AIBB1 504	5 x4	320,00 ₺
AIBB1 506	5 x6	320,00 ₺
AIBB1 510	5 x10	370,00 ₺
AIBB1 516	5 x16	385,00 ₺
AIBB1 525	5 x25	425,00 ₺
AIBB1 535	5 x35	445,00 ₺
AIBB1 550	5 x50	490,00 ₺
AIBB1 570	5 x70	565,00 ₺
AIBB1 595	5 x95	594,00 ₺
AIBB1 5120	5 x120	680,00 ₺
AIBB1 5150	5 x150	710,00 ₺
AIBB1 5185	5 x185	845,00 ₺



AG ALÜMİNYUN İLETKENLİ ÇOK DAMARLI ISI BÜZÜŞMELİ KABLO BAŞLIKLARI

L.V. MULTI CORE HEAT SHRINKABLE CABLE TERMINATIONS FOR ALUMINUM CABLE

PAPUÇSUZ

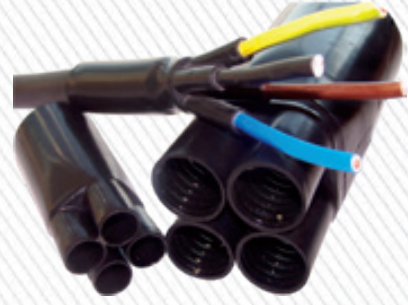
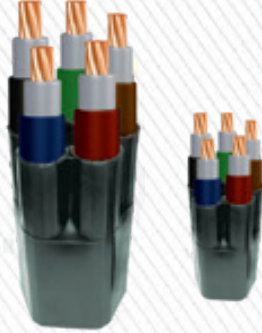

0.6-1 KV

KOD CODE	KABLO KESİTİ CROSS SECTION	FİYAT PRICE
4 DAMARLI PABUÇSUZ KABLO BAŞLIĞI		
AIBBX1 4205	4x2,5	190,00 ₺
AIBBX1 404	4x4	190,00 ₺
AIBBX1 406	4x6	190,00 ₺
AIBBX1 410	4x10	190,00 ₺
AIBBX1 416	4x16	190,00 ₺
AIBBX1 425	4x25	190,00 ₺
AIBBX1 435	4x35	305,00 ₺
AIBBX1 450	4x50	305,00 ₺
AIBBX1 470	4x70	305,00 ₺
AIBBX1 495	4x95	305,00 ₺
AIBBX1 4120	4x120	380,00 ₺
AIBBX1 4150	4x150	380,00 ₺
AIBBX1 4185	4x185	380,00 ₺
AIBBX1 4240	4x240	455,00 ₺
AIBBX1 4300	4x300	455,00 ₺
AIBBX1 4400	4x400	455,00 ₺
AIBBX1 31610	3x16+10	190,00 ₺
AIBBX1 32516	3x25+16	190,00 ₺
AIBBX1 33516	3x35+16	305,00 ₺
AIBBX1 35025	3x50+25	305,00 ₺
AIBBX1 37035	3x70+35	305,00 ₺
AIBBX1 39550	3x95+50	305,00 ₺
AIBBX1 31207	3x120+70	380,00 ₺
AIBBX1 31507	3x150+70	380,00 ₺
AIBBX1 31859	3x185+95	380,00 ₺
AIBBX1 32401	3x240+120	455,00 ₺
AIBBX1 33001	3x300+150	455,00 ₺
AIBBX1 34001	3x400+185	455,00 ₺

KOD CODE	KABLO KESİTİ CROSS SECTION	FİYAT PRICE
2 DAMARLI PABUÇSUZ KABLO BAŞLIĞI		
AIBBX1 2205	2x2,5	160,00 ₺
AIBBX1 204	2x4	160,00 ₺
AIBBX1 206	2x6	160,00 ₺
AIBBX1 210	2x10	160,00 ₺
AIBBX1 216	2x16	160,00 ₺
AIBBX1 225	2x25	160,00 ₺
AIBBX1 235	2x35	280,00 ₺
AIBBX1 250	2x50	280,00 ₺
AIBBX1 270	2x70	280,00 ₺
AIBBX1 295	2x95	280,00 ₺
AIBBX1 2120	2x120	350,00 ₺
AIBBX1 2150	2x150	350,00 ₺
AIBBX1 2185	2x185	350,00 ₺

KOD CODE	KABLO KESİTİ CROSS SECTION	FİYAT PRICE
5 DAMARLI PABUÇSUZ KABLO BAŞLIĞI		
AIBBX1 5205	5 x2,5	240,00 ₺
AIBBX1 504	5 x4	240,00 ₺
AIBBX1 506	5 x6	240,00 ₺
AIBBX1 510	5 x10	240,00 ₺
AIBBX1 516	5 x16	240,00 ₺
AIBBX1 525	5 x25	240,00 ₺
AIBBX1 535	5 x35	400,00 ₺
AIBBX1 550	5 x50	400,00 ₺
AIBBX1 570	5 x70	400,00 ₺
AIBBX1 595	5 x95	400,00 ₺
AIBBX1 5120	5 x120	485,00 ₺
AIBBX1 5150	5 x150	485,00 ₺
AIBBX1 5185	5 x185	485,00 ₺





3.5-6 kV



5.8-10 kV

KOD CODE	KABLO KESİTİ CROSS SECTION	KOLİ ADETİ UNIT / BOX	FİYAT PRICE
IBH6 125	1x25+16	33	465,00 ₺
IBH6 135	1x35+16	33	465,00 ₺
IBH6 150	1x50+16	33	465,00 ₺
IBH6 170	1x70+16	33	475,00 ₺
IBH6 195	1x95+16	33	475,00 ₺
IBH6 1120	1x120+16	33	485,00 ₺
IBH6 1150	1x150+25	33	485,00 ₺
IBH6 1185	1x185+25	33	500,00 ₺
IBH6 1240	1x240+25	33	520,00 ₺
IBH6 1300	1x300+25	33	650,00 ₺
IBH6 1400	1x400+35	33	740,00 ₺
IBH6 1500	1x500+35	33	980,00 ₺
IBH6 1630	1x630+35	33	1.190,00 ₺

HARİCİ

KOD CODE	KABLO KESİTİ CROSS SECTION	KOLİ ADETİ UNIT / BOX	FİYAT PRICE
IBH10 125	1x25+16	33	465,00 ₺
IBH10 135	1x35+16	33	465,00 ₺
IBH10 150	1x50+16	33	465,00 ₺
IBH10 170	1x70+16	33	475,00 ₺
IBH10 195	1x95+16	33	475,00 ₺
IBH10 1120	1x120+16	33	485,00 ₺
IBH10 1150	1x150+25	33	485,00 ₺
IBH10 1185	1x185+25	33	500,00 ₺
IBH10 1240	1x240+25	33	520,00 ₺
IBH10 1300	1x300+25	33	650,00 ₺
IBH10 1400	1x400+35	33	740,00 ₺
IBH10 1500	1x500+35	33	980,00 ₺
IBH10 1630	1x630+35	33	1.190,00 ₺

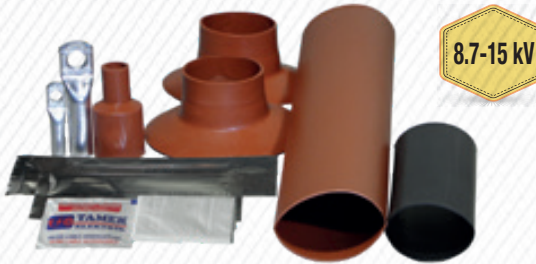

8.7-15 kV

20.8-36 kV



KOD CODE	KABLO KESİTİ CROSS SECTION	KOLİ ADETİ UNIT / BOX	FİYAT PRICE
IBH15 125	1x25+16	33	465,00 ₺
IBH15 135	1x35+16	33	465,00 ₺
IBH15 150	1x50+16	33	465,00 ₺
IBH15 170	1x70+16	33	475,00 ₺
IBH15 195	1x95+16	33	475,00 ₺
IBH15 1120	1x120+16	33	485,00 ₺
IBH15 1150	1x150+25	33	485,00 ₺
IBH15 1185	1x185+25	33	500,00 ₺
IBH15 1240	1x240+25	33	520,00 ₺
IBH15 1300	1x300+25	33	650,00 ₺
IBH15 1400	1x400+35	33	740,00 ₺
IBH15 1500	1x500+35	33	980,00 ₺
IBH15 1630	1x630+35	33	1.190,00 ₺

HARİCİ

KOD CODE	KABLO KESİTİ CROSS SECTION	KOLİ ADETİ UNIT / BOX	FİYAT PRICE
IBH36 125	1x25+16	33	700,00 ₺
IBH36 135	1x35+16	33	700,00 ₺
IBH36 150	1x50+16	33	700,00 ₺
IBH36 170	1x70+16	33	710,00 ₺
IBH36 195	1x95+16	33	710,00 ₺
IBH36 1120	1x120+16	33	725,00 ₺
IBH36 1150	1x150+25	33	725,00 ₺
IBH36 1185	1x185+25	33	735,00 ₺
IBH36 1240	1x240+25	33	735,00 ₺
IBH36 1300	1x300+25	33	875,00 ₺
IBH36 1400	1x400+35	33	965,00 ₺
IBH36 1500	1x500+35	33	1.215,00 ₺
IBH36 1630	1x630+35	33	1.455,00 ₺



O.G. BAKIR ÜÇ DAMARLI HARİCİ ISI BÜZÜŞMELİ KABLO BAŞLIKLARI

M.V. COPPER THREE CORES OUTDOOR HEAT SHRINKABLE CABLE TERMINATIONS



3.5-6 kV



5.8-10 kV

KOD CODE	KABLO KESİTİ CROSS SECTION	FİYAT PRICE
IBH6 325	3x25+16	2.250,00 ₺
IBH6 335	3x35+16	2.250,00 ₺
IBH6 350	3x50+16	2.285,00 ₺
IBH6 370	3x70+16	2.285,00 ₺
IBH6 395	3x95+16	2.320,00 ₺
IBH6 3120	3x120+16	2.500,00 ₺
IBH6 3150	3x150+25	2.500,00 ₺
IBH6 3185	3x185+25	2.530,00 ₺
IBH6 3240	3x240+25	2.530,00 ₺
IBH6 3300	3x300+25	2.745,00 ₺
IBH6 3400	3x400+35	2.780,00 ₺
IBH6 3500	3x500+35	3.025,00 ₺

H
A
R
I
C
I

KOD CODE	KABLO KESİTİ CROSS SECTION	FİYAT PRICE
IBH10 325	3x25+16	2.250,00 ₺
IBH10 335	3x35+16	2.250,00 ₺
IBH10 350	3x50+16	2.285,00 ₺
IBH10 370	3x70+16	2.285,00 ₺
IBH10 395	3x95+16	2.320,00 ₺
IBH10 3120	3x120+16	2.500,00 ₺
IBH10 3150	3x150+25	2.500,00 ₺
IBH10 3185	3x185+25	2.530,00 ₺
IBH10 3240	3x240+25	2.530,00 ₺
IBH10 3300	3x300+25	2.745,00 ₺
IBH10 3400	3x400+35	2.780,00 ₺
IBH10 3500	3x500+35	3.025,00 ₺



8.7-15 kV



20.8-36 kV

KOD CODE	KABLO KESİTİ CROSS SECTION	FİYAT PRICE
IBH15 325	3x25+16	2.250,00 ₺
IBH15 335	3x35+16	2.250,00 ₺
IBH15 350	3x50+16	2.285,00 ₺
IBH15 370	3x70+16	2.285,00 ₺
IBH15 395	3x95+16	2.320,00 ₺
IBH15 3120	3x120+16	2.500,00 ₺
IBH15 3150	3x150+25	2.500,00 ₺
IBH15 3185	3x185+25	2.530,00 ₺
IBH15 3240	3x240+25	2.530,00 ₺
IBH15 3300	3x300+25	2.745,00 ₺
IBH15 3400	3x400+35	2.780,00 ₺
IBH15 3500	3x500+35	3.025,00 ₺

H
A
R
I
C
I

KOD CODE	KABLO KESİTİ CROSS SECTION	FİYAT PRICE
IBH36 325	3x25+16	3.650,00 ₺
IBH36 335	3x35+16	3.650,00 ₺
IBH36 350	3x50+16	3.680,00 ₺
IBH36 370	3x70+16	3.680,00 ₺
IBH36 395	3x95+16	3.710,00 ₺
IBH36 3120	3x120+16	4.000,00 ₺
IBH36 3150	3x150+25	4.000,00 ₺
IBH36 3185	3x185+25	4.000,00 ₺
IBH36 3240	3x240+25	4.015,00 ₺
IBH36 3300	3x300+25	4.295,00 ₺
IBH36 3400	3x400+35	4.385,00 ₺
IBH36 3500	3x500+35	4.615,00 ₺





3.5-6 kV



5.8-10 kV

KOD CODE	KABLO KESİTİ CROSS SECTION	FİYAT PRICE
IBHA6 125	1x25+16	460,00 ₺
IBHA6 135	1x35+16	460,00 ₺
IBHA6 150	1x50+16	460,00 ₺
IBHA6 170	1x70+16	470,00 ₺
IBHA6 195	1x95+16	470,00 ₺
IBHA6 1120	1x120+16	480,00 ₺
IBHA6 1150	1x150+25	480,00 ₺
IBHA6 1185	1x185+25	495,00 ₺
IBHA6 1240	1x240+25	515,00 ₺
IBHA6 1300	1x300+25	645,00 ₺
IBHA6 1400	1x400+35	735,00 ₺
IBHA6 1500	1x500+35	975,00 ₺
IBHA6 1630	1x630+35	1.185,00 ₺

HARİCİ

KOD CODE	KABLO KESİTİ CROSS SECTION	FİYAT PRICE
IBHA10 125	1x25+16	460,00 ₺
IBHA10 135	1x35+16	460,00 ₺
IBHA10 150	1x50+16	460,00 ₺
IBHA10 170	1x70+16	470,00 ₺
IBHA10 195	1x95+16	470,00 ₺
IBHA10 1120	1x120+16	480,00 ₺
IBHA10 1150	1x150+25	480,00 ₺
IBHA10 1185	1x185+25	495,00 ₺
IBHA10 1240	1x240+25	515,00 ₺
IBHA10 1300	1x300+25	645,00 ₺
IBHA10 1400	1x400+35	735,00 ₺
IBHA10 1500	1x500+35	975,00 ₺
IBHA10 1630	1x630+35	1.185,00 ₺



8.7-15 kV



20.8-36 kV

KOD CODE	KABLO KESİTİ CROSS SECTION	FİYAT PRICE
IBHA15 125	1x25+16	460,00 ₺
IBHA15 135	1x35+16	460,00 ₺
IBHA15 150	1x50+16	460,00 ₺
IBHA15 170	1x70+16	470,00 ₺
IBHA15 195	1x95+16	470,00 ₺
IBHA15 1120	1x120+16	480,00 ₺
IBHA15 1150	1x150+25	480,00 ₺
IBHA15 1185	1x185+25	495,00 ₺
IBHA15 1240	1x240+25	515,00 ₺
IBHA15 1300	1x300+25	645,00 ₺
IBHA15 1400	1x400+35	735,00 ₺
IBHA15 1500	1x500+35	975,00 ₺
IBHA15 1630	1x630+35	1.185,00 ₺

HARİCİ

KOD CODE	KABLO KESİTİ CROSS SECTION	FİYAT PRICE
IBHA36 125	1x25+16	695,00 ₺
IBHA36 135	1x35+16	695,00 ₺
IBHA36 150	1x50+16	695,00 ₺
IBHA36 170	1x70+16	705,00 ₺
IBHA36 195	1x95+16	705,00 ₺
IBHA36 1120	1x120+16	720,00 ₺
IBHA36 1150	1x150+25	720,00 ₺
IBHA36 1185	1x185+25	730,00 ₺
IBHA36 1240	1x240+25	730,00 ₺
IBHA36 1300	1x300+25	870,00 ₺
IBHA36 1400	1x400+35	960,00 ₺
IBHA36 1500	1x500+35	1.210,00 ₺
IBHA36 1630	1x630+35	1.450,00 ₺

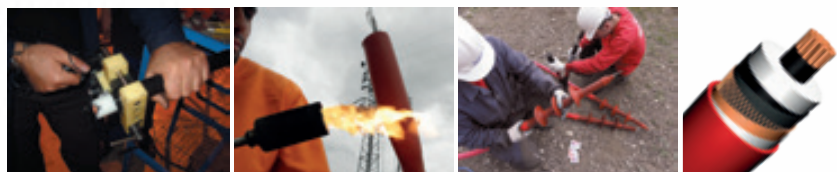

O.G. ALÜMİNYUM ÜÇ DAMARLI HARİCİ ISI BÜZÜŞMELİ KABLO BAŞLIKLARI

M.V. ALUMINUM THREE CORES OUTDOOR HEAT SHRINKABLE CABLE TERMINATIONS



3.5-6 kV



5.8-10 kV

KOD CODE	KABLO KESİTİ CROSS SECTION	FİYAT PRICE
IBHA6 325	3x25+16	2.245,00 ₺
IBHA6 335	3x35+16	2.245,00 ₺
IBHA6 350	3x50+16	2.280,00 ₺
IBHA6 370	3x70+16	2.280,00 ₺
IBHA6 395	3x95+16	2.315,00 ₺
IBHA6 3120	3x120+16	2.495,00 ₺
IBHA6 3150	3x150+25	2.495,00 ₺
IBHA6 3185	3x185+25	2.525,00 ₺
IBHA6 3240	3x240+25	2.525,00 ₺
IBHA6 3300	3x300+25	2.740,00 ₺
IBHA6 3400	3x400+35	2.775,00 ₺
IBHA6 3500	3x500+35	3.020,00 ₺

H
A
R
I
C
İ

KOD CODE	KABLO KESİTİ CROSS SECTION	FİYAT PRICE
IBHA10 325	3x25+16	2.245,00 ₺
IBHA10 335	3x35+16	2.245,00 ₺
IBHA10 350	3x50+16	2.280,00 ₺
IBHA10 370	3x70+16	2.280,00 ₺
IBHA10 395	3x95+16	2.315,00 ₺
IBHA10 3120	3x120+16	2.495,00 ₺
IBHA10 3150	3x150+25	2.495,00 ₺
IBHA10 3185	3x185+25	2.525,00 ₺
IBHA10 3240	3x240+25	2.525,00 ₺
IBHA10 3300	3x300+25	2.740,00 ₺
IBHA10 3400	3x400+35	2.775,00 ₺
IBHA10 3500	3x500+35	3.020,00 ₺



8.7-15 kV



20.8-36 kV

KOD CODE	KABLO KESİTİ CROSS SECTION	FİYAT PRICE
IBHA15 325	3x25+16	2.245,00 ₺
IBHA15 335	3x35+16	2.245,00 ₺
IBHA15 350	3x50+16	2.280,00 ₺
IBHA15 370	3x70+16	2.280,00 ₺
IBHA15 395	3x95+16	2.315,00 ₺
IBHA15 3120	3x120+16	2.495,00 ₺
IBHA15 3150	3x150+25	2.495,00 ₺
IBHA15 3185	3x185+25	2.525,00 ₺
IBHA15 3240	3x240+25	2.525,00 ₺
IBHA15 3300	3x300+25	2.740,00 ₺
IBHA15 3400	3x400+35	2.775,00 ₺
IBHA15 3500	3x500+35	3.020,00 ₺

H
A
R
I
C
İ

KOD CODE	KABLO KESİTİ CROSS SECTION	FİYAT PRICE
IBHA36 325	3x25+16	3.645,00 ₺
IBHA36 335	3x35+16	3.645,00 ₺
IBHA36 350	3x50+16	3.675,00 ₺
IBHA36 370	3x70+16	3.675,00 ₺
IBHA36 395	3x95+16	3.705,00 ₺
IBHA36 3120	3x120+16	3.995,00 ₺
IBHA36 3150	3x150+25	3.995,00 ₺
IBHA36 3185	3x185+25	3.995,00 ₺
IBHA36 3240	3x240+25	4.010,00 ₺
IBHA36 3300	3x300+25	4.290,00 ₺
IBHA36 3400	3x400+35	4.380,00 ₺
IBHA36 3500	3x500+35	4.610,00 ₺



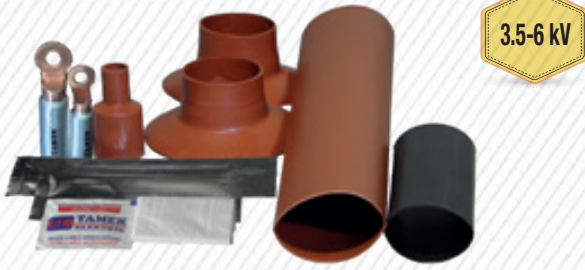

3.5-6 kV



5.8-10 kV

KOD CODE	KABLO KESİTİ CROSS SECTION	FİYAT PRICE
IBHB6 125	1x25+16	700,00 ₺
IBHB6 135	1x35+16	700,00 ₺
IBHB6 150	1x50+16	700,00 ₺
IBHB6 170	1x70+16	710,00 ₺
IBHB6 195	1x95+16	710,00 ₺
IBHB6 1120	1x120+16	720,00 ₺
IBHB6 1150	1x150+25	720,00 ₺
IBHB6 1185	1x185+25	745,00 ₺
IBHB6 1240	1x240+25	795,00 ₺
IBHB6 1300	1x300+25	965,00 ₺
IBHB6 1400	1x400+35	1.110,00 ₺

HARİCİ

KOD CODE	KABLO KESİTİ CROSS SECTION	FİYAT PRICE
IBHB10 125	1x25+16	700,00 ₺
IBHB10 135	1x35+16	700,00 ₺
IBHB10 150	1x50+16	700,00 ₺
IBHB10 170	1x70+16	710,00 ₺
IBHB10 195	1x95+16	710,00 ₺
IBHB10 1120	1x120+16	720,00 ₺
IBHB10 1150	1x150+25	720,00 ₺
IBHB10 1185	1x185+25	745,00 ₺
IBHB10 1240	1x240+25	795,00 ₺
IBHB10 1300	1x300+25	965,00 ₺
IBHB10 1400	1x400+35	1.110,00 ₺



8.7-15 kV



20.8-36 kV

KOD CODE	KABLO KESİTİ CROSS SECTION	FİYAT PRICE
IBHB15 125	1x25+16	700,00 ₺
IBHB15 135	1x35+16	700,00 ₺
IBHB15 150	1x50+16	700,00 ₺
IBHB15 170	1x70+16	710,00 ₺
IBHB15 195	1x95+16	710,00 ₺
IBHB15 1120	1x120+16	720,00 ₺
IBHB15 1150	1x150+25	720,00 ₺
IBHB15 1185	1x185+25	745,00 ₺
IBHB15 1240	1x240+25	795,00 ₺
IBHB15 1300	1x300+25	965,00 ₺
IBHB15 1400	1x400+35	1.110,00 ₺

HARİCİ

KOD CODE	KABLO KESİTİ CROSS SECTION	FİYAT PRICE
IBHB36 125	1x25+16	875,00 ₺
IBHB36 135	1x35+16	875,00 ₺
IBHB36 150	1x50+16	875,00 ₺
IBHB36 170	1x70+16	890,00 ₺
IBHB36 195	1x95+16	890,00 ₺
IBHB36 1120	1x120+16	910,00 ₺
IBHB36 1150	1x150+25	910,00 ₺
IBHB36 1185	1x185+25	920,00 ₺
IBHB36 1240	1x240+25	920,00 ₺
IBHB36 1300	1x300+25	1.095,00 ₺
IBHB36 1400	1x400+35	1.210,00 ₺

O.G. BİMETAL 3 DAMARLI HARİCİ ISI BÜZÜŞMELİ KABLO BAŞLIKLARI

M.V. BIMETALLIC 3 CORE OUTDOOR HEAT SHRINKABLE CABLE TERMINATIONS

3.5-6 kV



5.8-10 kV



KOD CODE	KABLO KESİTİ CROSS SECTION	FİYAT PRICE
IBHB6 325	3x25+16	2.660,00 ₺
IBHB6 335	3x35+16	2.660,00 ₺
IBHB6 350	3x50+16	2.690,00 ₺
IBHB6 370	3x70+16	2.690,00 ₺
IBHB6 395	3x95+16	2.730,00 ₺
IBHB6 3120	3x120+16	2.730,00 ₺
IBHB6 3150	3x150+25	2.730,00 ₺
IBHB6 3185	3x185+25	2.980,00 ₺
IBHB6 3240	3x240+25	2.980,00 ₺
IBHB6 3300	3x300+25	3.230,00 ₺
IBHB6 3400	3x400+35	3.270,00 ₺

H
A
R
I
C
I

KOD CODE	KABLO KESİTİ CROSS SECTION	FİYAT PRICE
IBHB10 325	3x25+16	2.660,00 ₺
IBHB10 335	3x35+16	2.660,00 ₺
IBHB10 350	3x50+16	2.690,00 ₺
IBHB10 370	3x70+16	2.690,00 ₺
IBHB10 395	3x95+16	2.730,00 ₺
IBHB10 3120	3x120+16	2.730,00 ₺
IBHB10 3150	3x150+25	2.730,00 ₺
IBHB10 3185	3x185+25	2.980,00 ₺
IBHB10 3240	3x240+25	2.980,00 ₺
IBHB10 3300	3x300+25	3.230,00 ₺
IBHB10 3400	3x400+35	3.270,00 ₺

8.7-15 kV



20.8-36 kV



KOD CODE	KABLO KESİTİ CROSS SECTION	FİYAT PRICE
IBHB15 325	3x25+16	2.660,00 ₺
IBHB15 335	3x35+16	2.660,00 ₺
IBHB15 350	3x50+16	2.690,00 ₺
IBHB15 370	3x70+16	2.690,00 ₺
IBHB15 395	3x95+16	2.730,00 ₺
IBHB15 3120	3x120+16	2.730,00 ₺
IBHB15 3150	3x150+25	2.730,00 ₺
IBHB15 3185	3x185+25	2.980,00 ₺
IBHB15 3240	3x240+25	2.980,00 ₺
IBHB15 3300	3x300+25	3.230,00 ₺
IBHB15 3400	3x400+35	3.270,00 ₺

H
A
R
I
C
I

KOD CODE	KABLO KESİTİ CROSS SECTION	FİYAT PRICE
IBHB36 325	3x25+16	3.530,00 ₺
IBHB36 335	3x35+16	3.530,00 ₺
IBHB36 350	3x50+16	3.560,00 ₺
IBHB36 370	3x70+16	3.560,00 ₺
IBHB36 395	3x95+16	3.590,00 ₺
IBHB36 3120	3x120+16	3.850,00 ₺
IBHB36 3150	3x150+25	3.850,00 ₺
IBHB36 3185	3x185+25	3.850,00 ₺
IBHB36 3240	3x240+25	3.870,00 ₺
IBHB36 3300	3x300+25	4.140,00 ₺
IBHB36 3400	3x400+35	4.480,00 ₺



3.5-6 kV

5.8-10 kV



KOD CODE	KABLO KESİTİ CROSS SECTION	FİYAT PRICE
MIBH6 125-195	1x25+16-1x95+16	810,00 ₺
MIBH6 1120-1240	1x120+16-1x240+25	1.215,00 ₺
MIBH6 1300-1400	1x300+25-1x400+35	1.375,00 ₺

KOD CODE	KABLO KESİTİ CROSS SECTION	FİYAT PRICE
MIBH10 125-195	1x25+16-1x95+16	810,00 ₺
MIBH10 1120-1240	1x120+16-1x240+25	1.215,00 ₺
MIBH10 1300-1400	1x300+25-1x400+35	1.375,00 ₺

HARİCİ



8.7-15 kV

20.8-36 kV



KOD CODE	KABLO KESİTİ CROSS SECTION	FİYAT PRICE
MIBH15 125-195	1x25+16-1x95+16	810,00 ₺
MIBH15 1120-1240	1x120+16-1x240+25	1.215,00 ₺
MIBH15 1300-1400	1x300+25-1x400+35	1.375,00 ₺

KOD CODE	KABLO KESİTİ CROSS SECTION	FİYAT PRICE
MIBH36 135-195	1x35+16-1x95+16	1.120,00 ₺
MIBH36 1120-1240	1x120+16-1x240+25	1.380,00 ₺
MIBH36 1300-1400	1x300+25-1x400+35	1.650,00 ₺

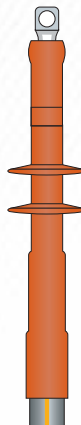

O.G. MEKANİK ÜÇ DAMARLI HARİCİ ISI BÜZÜŞMELİ KABLO BAŞLIĞI

M.V. BOLTED THREE CORES OUTDOOR HEAT SHRINKABLE CABLE TERMINATIONS



3.5-6 kV



5.8-10 kV

KOD CODE	KABLO KESİTİ CROSS SECTION	FİYAT PRICE
MIBH6 325-395	3x25+16-3x95+16	3.230,00 ₺
MIBH6 3120-3240	3x120+16-3x240+25	3.400,00 ₺
MIBH6 3300-3400	3x300+25-3x400+35	5.345,00 ₺

KOD CODE	KABLO KESİTİ CROSS SECTION	FİYAT PRICE
MIBH10 325-395	3x25+16-3x95+16	3.230,00 ₺
MIBH10 3120-3240	3x120+16-3x240+25	3.400,00 ₺
MIBH10 3300-3400	3x300+25-3x400+35	5.345,00 ₺

H
A
R
I
C
I

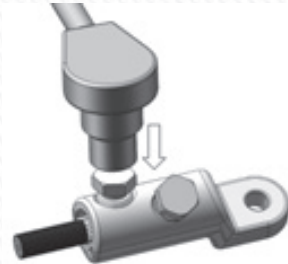

8.7-15 kV



20.8-36 kV

KOD CODE	KABLO KESİTİ CROSS SECTION	FİYAT PRICE
MIBH15 325-395	3x25+16-3x95+16	3.230,00 ₺
MIBH15 3120-3240	3x120+16-3x240+25	3.400,00 ₺
MIBH15 3300-3400	3x300+25-3x400+35	5.345,00 ₺

KOD CODE	KABLO KESİTİ CROSS SECTION	FİYAT PRICE
MIBH36 335-395	3x35+16-3x95+16	4.340,00 ₺
MIBH36 3120-3240	3x120+16-3x240+25	4.610,00 ₺
MIBH36 3300-3400	3x300+25-3x400+35	6.060,00 ₺

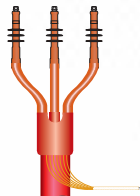

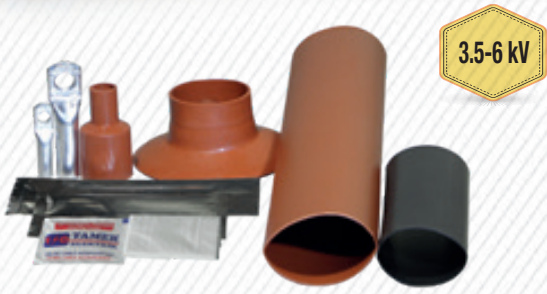

3.5-6 kV



5.8-10 kV

KOD CODE	KABLO KESİTİ CROSS SECTION	KOLİ ADETİ UNIT / BOX	FIYAT PRICE
IBD6 125	1x25+16	33	340,00 ₺
IBD6 135	1x35+16	33	340,00 ₺
IBD6 150	1x50+16	33	340,00 ₺
IBD6 170	1x70+16	33	350,00 ₺
IBD6 195	1x95+16	33	350,00 ₺
IBD6 1120	1x120+16	33	360,00 ₺
IBD6 1150	1x150+25	33	360,00 ₺
IBD6 1185	1x185+25	33	365,00 ₺
IBD6 1240	1x240+25	33	395,00 ₺
IBD6 1300	1x300+25	33	480,00 ₺
IBD6 1400	1x400+35	33	585,00 ₺
IBD6 1500	1x500+35	33	830,00 ₺
IBD6 1630	1x630+35	33	1.020,00 ₺

DAHİLİ

KOD CODE	KABLO KESİTİ CROSS SECTION	KOLİ ADETİ UNIT / BOX	FIYAT PRICE
IBD10 125	1x25+16	33	340,00 ₺
IBD10 135	1x35+16	33	340,00 ₺
IBD10 150	1x50+16	33	340,00 ₺
IBD10 170	1x70+16	33	350,00 ₺
IBD10 195	1x95+16	33	350,00 ₺
IBD10 1120	1x120+16	33	360,00 ₺
IBD10 1150	1x150+25	33	360,00 ₺
IBD10 1185	1x185+25	33	365,00 ₺
IBD10 1240	1x240+25	33	395,00 ₺
IBD10 1300	1x300+25	33	480,00 ₺
IBD10 1400	1x400+35	33	585,00 ₺
IBD10 1500	1x500+35	33	830,00 ₺
IBD10 1630	1x630+35	33	1.020,00 ₺

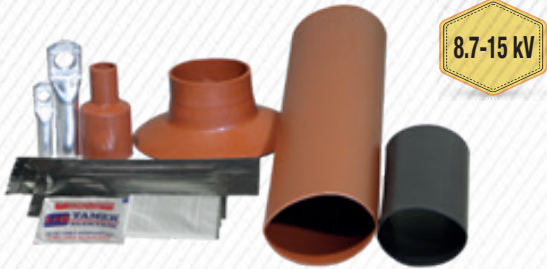

8.7-15 kV



20.8-36 kV

KOD CODE	KABLO KESİTİ CROSS SECTION	KOLİ ADETİ UNIT / BOX	FIYAT PRICE
IBD15 125	1x25+16	33	340,00 ₺
IBD15 135	1x35+16	33	340,00 ₺
IBD15 150	1x50+16	33	340,00 ₺
IBD15 170	1x70+16	33	350,00 ₺
IBD15 195	1x95+16	33	350,00 ₺
IBD15 1120	1x120+16	33	360,00 ₺
IBD15 1150	1x150+25	33	360,00 ₺
IBD15 1185	1x185+25	33	365,00 ₺
IBD15 1240	1x240+25	33	395,00 ₺
IBD15 1300	1x300+25	33	480,00 ₺
IBD15 1400	1x400+35	33	585,00 ₺
IBD15 1500	1x500+35	33	830,00 ₺
IBD15 1630	1x630+35	33	1.020,00 ₺

DAHİLİ

KOD CODE	KABLO KESİTİ CROSS SECTION	KOLİ ADETİ UNIT / BOX	FIYAT PRICE
IBD36 125	1x25+16	33	465,00 ₺
IBD36 135	1x35+16	33	465,00 ₺
IBD36 150	1x50+16	33	465,00 ₺
IBD36 170	1x70+16	33	470,00 ₺
IBD36 195	1x95+16	33	470,00 ₺
IBD36 1120	1x120+16	33	480,00 ₺
IBD36 1150	1x150+25	33	480,00 ₺
IBD36 1185	1x185+25	33	500,00 ₺
IBD36 1240	1x240+25	33	515,00 ₺
IBD36 1300	1x300+25	33	700,00 ₺
IBD36 1400	1x400+35	33	795,00 ₺
IBD36 1500	1x500+35	33	1.040,00 ₺
IBD36 1630	1x630+35	33	1.260,00 ₺



O.G. BAKIR ÜÇ DAMARLI DAHİLİ ISI BÜZÜŞMELİ KABLO BAŞLIKLARI

M.V. COPPER THREE CORES INDOOR HEAT SHRINKABLE CABLE TERMINATIONS



3.5-6 kV



5.8-10 kV

KOD CODE	KABLO KESİTİ CROSS SECTION	FİYAT PRICE
IBD6 325	3x25+16	1.920,00 ₺
IBD6 335	3x35+16	1.920,00 ₺
IBD6 350	3x50+16	1.960,00 ₺
IBD6 370	3x70+16	1.960,00 ₺
IBD6 395	3x95+16	2.000,00 ₺
IBD6 3120	3x120+16	2.190,00 ₺
IBD6 3150	3x150+25	2.190,00 ₺
IBD6 3185	3x185+25	2.230,00 ₺
IBD6 3240	3x240+25	2.230,00 ₺
IBD6 3300	3x300+25	2.375,00 ₺
IBD6 3400	3x400+35	2.480,00 ₺
IBD6 3500	3x500+35	2.765,00 ₺

DAHİLİ

KOD CODE	KABLO KESİTİ CROSS SECTION	FİYAT PRICE
IBD10 325	3x25+16	1.920,00 ₺
IBD10 335	3x35+16	1.920,00 ₺
IBD10 350	3x50+16	1.960,00 ₺
IBD10 370	3x70+16	1.960,00 ₺
IBD10 395	3x95+16	2.000,00 ₺
IBD10 3120	3x120+16	2.190,00 ₺
IBD10 3150	3x150+25	2.190,00 ₺
IBD10 3185	3x185+25	2.230,00 ₺
IBD10 3240	3x240+25	2.230,00 ₺
IBD10 3300	3x300+25	2.375,00 ₺
IBD10 3400	3x400+35	2.480,00 ₺
IBD10 3500	3x500+35	2.765,00 ₺



8.7-15 kV

20.8-36 kV

KOD CODE	KABLO KESİTİ CROSS SECTION	FİYAT PRICE
IBD15 325	3x25+16	1.920,00 ₺
IBD15 335	3x35+16	1.920,00 ₺
IBD15 350	3x50+16	1.960,00 ₺
IBD15 370	3x70+16	1.960,00 ₺
IBD15 395	3x95+16	2.000,00 ₺
IBD15 3120	3x120+16	2.190,00 ₺
IBD15 3150	3x150+25	2.190,00 ₺
IBD15 3185	3x185+25	2.230,00 ₺
IBD15 3240	3x240+25	2.230,00 ₺
IBD15 3300	3x300+25	2.375,00 ₺
IBD15 3400	3x400+35	2.480,00 ₺
IBD15 3500	3x500+35	2.765,00 ₺

DAHİLİ

KOD CODE	KABLO KESİTİ CROSS SECTION	FİYAT PRICE
IBD36 325	3x25+16	2.830,00 ₺
IBD36 335	3x35+16	2.830,00 ₺
IBD36 350	3x50+16	2.870,00 ₺
IBD36 370	3x70+16	2.875,00 ₺
IBD36 395	3x95+16	2.895,00 ₺
IBD36 3120	3x120+16	3.150,00 ₺
IBD36 3150	3x150+25	3.150,00 ₺
IBD36 3185	3x185+25	3.180,00 ₺
IBD36 3240	3x240+25	3.180,00 ₺
IBD36 3300	3x300+25	3.485,00 ₺
IBD36 3400	3x400+35	3.580,00 ₺
IBD36 3500	3x500+35	3.850,00 ₺



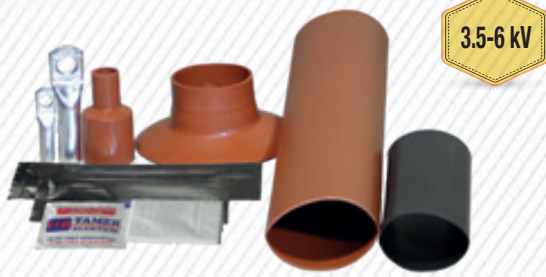

3.5-6 kV



5.8-10 kV

KOD CODE	KABLO KESİTİ CROSS SECTION	KOLİ ADETİ UNIT / BOX	FİYAT PRICE
IBDA6 125	1x25+16	33	335,00 ₺
IBDA6 135	1x35+16	33	335,00 ₺
IBDA6 150	1x50+16	33	335,00 ₺
IBDA6 170	1x70+16	33	345,00 ₺
IBDA6 195	1x95+16	33	345,00 ₺
IBDA6 1120	1x120+16	33	355,00 ₺
IBDA6 1150	1x150+25	33	355,00 ₺
IBDA6 1185	1x185+25	33	360,00 ₺
IBDA6 1240	1x240+25	33	390,00 ₺
IBDA6 1300	1x300+25	33	475,00 ₺
IBDA6 1400	1x400+35	33	580,00 ₺
IBDA6 1500	1x500+35	33	825,00 ₺
IBDA6 1630	1x630+35	33	1.015,00 ₺

KOD CODE	KABLO KESİTİ CROSS SECTION	KOLİ ADETİ UNIT / BOX	FİYAT PRICE
IBDA10 125	1x25+16	33	335,00 ₺
IBDA10 135	1x35+16	33	335,00 ₺
IBDA10 150	1x50+16	33	335,00 ₺
IBDA10 170	1x70+16	33	345,00 ₺
IBDA10 195	1x95+16	33	345,00 ₺
IBDA10 1120	1x120+16	33	355,00 ₺
IBDA10 1150	1x150+25	33	355,00 ₺
IBDA10 1185	1x185+25	33	360,00 ₺
IBDA10 1240	1x240+25	33	390,00 ₺
IBDA10 1300	1x300+25	33	475,00 ₺
IBDA10 1400	1x400+35	33	580,00 ₺
IBDA10 1500	1x500+35	33	825,00 ₺
IBDA10 1630	1x630+35	33	1.015,00 ₺

DAHİLİ

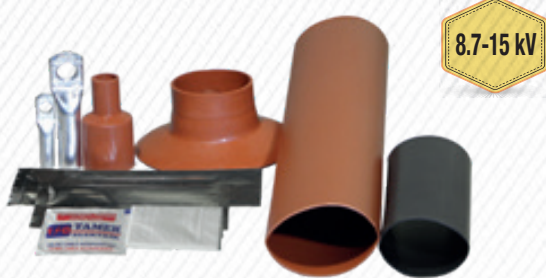

8.7-15 kV



20.8-36 kV

KOD CODE	KABLO KESİTİ CROSS SECTION	KOLİ ADETİ UNIT / BOX	FİYAT PRICE
IBDA15 125	1x25+16	33	335,00 ₺
IBDA15 135	1x35+16	33	335,00 ₺
IBDA15 150	1x50+16	33	335,00 ₺
IBDA15 170	1x70+16	33	345,00 ₺
IBDA15 195	1x95+16	33	345,00 ₺
IBDA15 1120	1x120+16	33	355,00 ₺
IBDA15 1150	1x150+25	33	355,00 ₺
IBDA15 1185	1x185+25	33	360,00 ₺
IBDA15 1240	1x240+25	33	390,00 ₺
IBDA15 1300	1x300+25	33	475,00 ₺
IBDA15 1400	1x400+35	33	580,00 ₺
IBDA15 1500	1x500+35	33	825,00 ₺
IBDA15 1630	1x630+35	33	1.015,00 ₺

KOD CODE	KABLO KESİTİ CROSS SECTION	KOLİ ADETİ UNIT / BOX	FİYAT PRICE
IBDA36 125	1x25+16	33	460,00 ₺
IBDA36 135	1x35+16	33	460,00 ₺
IBDA36 150	1x50+16	33	460,00 ₺
IBDA36 170	1x70+16	33	465,00 ₺
IBDA36 195	1x95+16	33	465,00 ₺
IBDA36 1120	1x120+16	33	475,00 ₺
IBDA36 1150	1x150+25	33	475,00 ₺
IBDA36 1185	1x185+25	33	495,00 ₺
IBDA36 1240	1x240+25	33	510,00 ₺
IBDA36 1300	1x300+25	33	695,00 ₺
IBDA36 1400	1x400+35	33	790,00 ₺
IBDA36 1500	1x500+35	33	1.035,00 ₺
IBDA36 1630	1x630+35	33	1.255,00 ₺

DAHİLİ



O.G. ALÜMİNYUM ÜÇ DAMARLI DAHİLİ ISI BÜZÜŞMELİ KABLO BAŞLIKLARI

M.V. ALUMINUM THREE CORES INDOOR HEAT SHRINKABLE CABLE TERMINATIONS



3.5-6 kV



5.8-10 kV

KOD CODE	KABLO KESİTİ CROSS SECTION	FİYAT PRICE
IBDA6 325	3x25+16	1.915,00 ₺
IBDA6 335	3x35+16	1.915,00 ₺
IBDA6 350	3x50+16	1.955,00 ₺
IBDA6 370	3x70+16	1.955,00 ₺
IBDA6 395	3x95+16	1.995,00 ₺
IBDA6 3120	3x120+16	2.185,00 ₺
IBDA6 3150	3x150+25	2.185,00 ₺
IBDA6 3185	3x185+25	2.225,00 ₺
IBDA6 3240	3x240+25	2.225,00 ₺
IBDA6 3300	3x300+25	2.370,00 ₺
IBDA6 3400	3x400+35	2.475,00 ₺
IBDA6 3500	3x500+35	2.760,00 ₺

DAHİLİ

KOD CODE	KABLO KESİTİ CROSS SECTION	FİYAT PRICE
IBDA10 325	3x25+16	1.915,00 ₺
IBDA10 335	3x35+16	1.915,00 ₺
IBDA10 350	3x50+16	1.955,00 ₺
IBDA10 370	3x70+16	1.955,00 ₺
IBDA10 395	3x95+16	1.995,00 ₺
IBDA10 3120	3x120+16	2.185,00 ₺
IBDA10 3150	3x150+25	2.185,00 ₺
IBDA10 3185	3x185+25	2.225,00 ₺
IBDA10 3240	3x240+25	2.225,00 ₺
IBDA10 3300	3x300+25	2.370,00 ₺
IBDA10 3400	3x400+35	2.475,00 ₺
IBDA10 3500	3x500+35	2.760,00 ₺



8.7-15 kV

20.8-36 kV

KOD CODE	KABLO KESİTİ CROSS SECTION	FİYAT PRICE
IBDA15 325	3x25+16	1.915,00 ₺
IBDA15 335	3x35+16	1.915,00 ₺
IBDA15 350	3x50+16	1.955,00 ₺
IBDA15 370	3x70+16	1.955,00 ₺
IBDA15 395	3x95+16	1.995,00 ₺
IBDA15 3120	3x120+16	2.185,00 ₺
IBDA15 3150	3x150+25	2.185,00 ₺
IBDA15 3185	3x185+25	2.225,00 ₺
IBDA15 3240	3x240+25	2.225,00 ₺
IBDA15 3300	3x300+25	2.370,00 ₺
IBDA15 3400	3x400+35	2.475,00 ₺
IBDA15 3500	3x500+35	2.760,00 ₺

DAHİLİ

KOD CODE	KABLO KESİTİ CROSS SECTION	FİYAT PRICE
IBDA36 325	3x25+16	2.825,00 ₺
IBDA36 335	3x35+16	2.825,00 ₺
IBDA36 350	3x50+16	2.865,00 ₺
IBDA36 370	3x70+16	2.870,00 ₺
IBDA36 395	3x95+16	2.890,00 ₺
IBDA36 3120	3x120+16	3.145,00 ₺
IBDA36 3150	3x150+25	3.145,00 ₺
IBDA36 3185	3x185+25	3.175,00 ₺
IBDA36 3240	3x240+25	3.175,00 ₺
IBDA36 3300	3x300+25	3.480,00 ₺
IBDA36 3400	3x400+35	3.575,00 ₺
IBDA36 3500	3x500+35	3.845,00 ₺





3.5-6 kV



5.8-10 kV

KOD CODE	KABLO KESİTİ CROSS SECTION	FİYAT PRICE
IBDB6 125	1x25+16	405,00 ₺
IBDB6 135	1x35+16	405,00 ₺
IBDB6 150	1x50+16	405,00 ₺
IBDB6 170	1x70+16	415,00 ₺
IBDB6 195	1x95+16	415,00 ₺
IBDB6 1120	1x120+16	440,00 ₺
IBDB6 1150	1x150+25	440,00 ₺
IBDB6 1185	1x185+25	445,00 ₺
IBDB6 1240	1x240+25	470,00 ₺
IBDB6 1300	1x300+25	590,00 ₺
IBDB6 1400	1x400+35	710,00 ₺

DAHİLİ

KOD CODE	KABLO KESİTİ CROSS SECTION	FİYAT PRICE
IBDB10 125	1x25+16	405,00 ₺
IBDB10 135	1x35+16	405,00 ₺
IBDB10 150	1x50+16	405,00 ₺
IBDB10 170	1x70+16	415,00 ₺
IBDB10 195	1x95+16	415,00 ₺
IBDB10 1120	1x120+16	440,00 ₺
IBDB10 1150	1x150+25	440,00 ₺
IBDB10 1185	1x185+25	445,00 ₺
IBDB10 1240	1x240+25	470,00 ₺
IBDB10 1300	1x300+25	590,00 ₺
IBDB10 1400	1x400+35	710,00 ₺



8.7-15 kV



20.8-36 kV

KOD CODE	KABLO KESİTİ CROSS SECTION	FİYAT PRICE
IBDB15 125	1x25+16	405,00 ₺
IBDB15 135	1x35+16	405,00 ₺
IBDB15 150	1x50+16	405,00 ₺
IBDB15 170	1x70+16	415,00 ₺
IBDB15 195	1x95+16	415,00 ₺
IBDB15 1120	1x120+16	440,00 ₺
IBDB15 1150	1x150+25	440,00 ₺
IBDB15 1185	1x185+25	445,00 ₺
IBDB15 1240	1x240+25	470,00 ₺
IBDB15 1300	1x300+25	590,00 ₺
IBDB15 1400	1x400+35	710,00 ₺

DAHİLİ

KOD CODE	KABLO KESİTİ CROSS SECTION	FİYAT PRICE
IBDB36 125	1x25+16	565,00 ₺
IBDB36 135	1x35+16	565,00 ₺
IBDB36 150	1x50+16	565,00 ₺
IBDB36 170	1x70+16	570,00 ₺
IBDB36 195	1x95+16	570,00 ₺
IBDB36 1120	1x120+16	580,00 ₺
IBDB36 1150	1x150+25	580,00 ₺
IBDB36 1185	1x185+25	605,00 ₺
IBDB36 1240	1x240+25	630,00 ₺
IBDB36 1300	1x300+25	850,00 ₺
IBDB36 1400	1x400+35	965,00 ₺

O.G. BİMETAL 3 DAMARLI DAHİLİ ISI BÜZÜŞMELİ KABLO BAŞLIKLARI

M.V. BIMETALLIC 3 CORE INDOOR HEAT SHRINKABLE CABLE TERMINATIONS



3.5-6 kV



5.8-10 kV

KOD CODE	KABLO KESİTİ CROSS SECTION	FİYAT PRICE
IBDB6 325	3x25+16	1.880,00 ₺
IBDB6 335	3x35+16	1.880,00 ₺
IBDB6 350	3x50+16	1.950,00 ₺
IBDB6 370	3x70+16	1.950,00 ₺
IBDB6 395	3x95+16	2.020,00 ₺
IBDB6 3120	3x120+16	2.185,00 ₺
IBDB6 3150	3x150+25	2.185,00 ₺
IBDB6 3185	3x185+25	2.355,00 ₺
IBDB6 3240	3x240+25	2.355,00 ₺
IBDB6 3300	3x300+25	2.690,00 ₺
IBDB6 3400	3x400+35	2.855,00 ₺

DAHİLİ

KOD CODE	KABLO KESİTİ CROSS SECTION	FİYAT PRICE
IBDB10 325	3x25+16	1.880,00 ₺
IBDB10 335	3x35+16	1.880,00 ₺
IBDB10 350	3x50+16	1.950,00 ₺
IBDB10 370	3x70+16	1.950,00 ₺
IBDB10 395	3x95+16	2.020,00 ₺
IBDB10 3120	3x120+16	2.185,00 ₺
IBDB10 3150	3x150+25	2.185,00 ₺
IBDB10 3185	3x185+25	2.355,00 ₺
IBDB10 3240	3x240+25	2.355,00 ₺
IBDB10 3300	3x300+25	2.690,00 ₺
IBDB10 3400	3x400+35	2.855,00 ₺



8.7-15 kV

20.8-36 kV



KOD CODE	KABLO KESİTİ CROSS SECTION	FİYAT PRICE
IBDB15 325	3x25+16	1.880,00 ₺
IBDB15 335	3x35+16	1.880,00 ₺
IBDB15 350	3x50+16	1.950,00 ₺
IBDB15 370	3x70+16	1.950,00 ₺
IBDB15 395	3x95+16	2.020,00 ₺
IBDB15 3120	3x120+16	2.185,00 ₺
IBDB15 3150	3x150+25	2.185,00 ₺
IBDB15 3185	3x185+25	2.355,00 ₺
IBDB15 3240	3x240+25	2.355,00 ₺
IBDB15 3300	3x300+25	2.690,00 ₺
IBDB15 3400	3x400+35	2.855,00 ₺

DAHİLİ

KOD CODE	KABLO KESİTİ CROSS SECTION	FİYAT PRICE
IBDB36 325	3x25+16	2.860,00 ₺
IBDB36 335	3x35+16	2.860,00 ₺
IBDB36 350	3x50+16	2.900,00 ₺
IBDB36 370	3x70+16	3.125,00 ₺
IBDB36 395	3x95+16	3.180,00 ₺
IBDB36 3120	3x120+16	3.180,00 ₺
IBDB36 3150	3x150+25	3.215,00 ₺
IBDB36 3185	3x185+25	3.215,00 ₺
IBDB36 3240	3x240+25	3.525,00 ₺
IBDB36 3300	3x300+25	3.620,00 ₺
IBDB36 3400	3x400+35	1.042,00 ₺

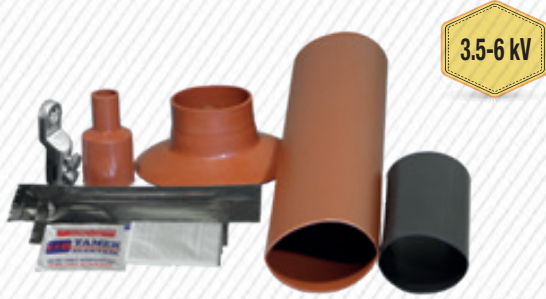

3.5-6 kV

5.8-10 kV



KOD CODE	KABLO KESİTİ CROSS SECTION	FİYAT PRICE
MIBD6 125-195	1x25+16-1x95+16	710,00 ₺
MIBD6 1120-1240	1x120+16-1x240+25	900,00 ₺
MIBD6 1300-1400	1x300+25-1x400+35	1.120,00 ₺

KOD CODE	KABLO KESİTİ CROSS SECTION	FİYAT PRICE
MIBD10 125-195	1x25+16-1x95+16	710,00 ₺
MIBD10 1120-1240	1x120+16-1x240+25	900,00 ₺
MIBD10 1300-1400	1x300+25-1x400+35	1.120,00 ₺

DAHİLİ

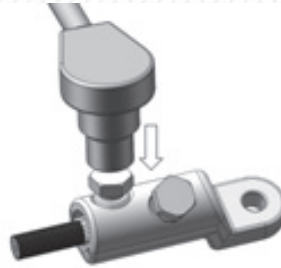

8.7-15 kV

20.8-36 kV



KOD CODE	KABLO KESİTİ CROSS SECTION	FİYAT PRICE
MIBD15 125-195	1x25+16-1x95+16	710,00 ₺
MIBD15 1120-1240	1x120+16-1x240+25	900,00 ₺
MIBD15 1300-1400	1x300+25-1x400+35	1.120,00 ₺

KOD CODE	KABLO KESİTİ CROSS SECTION	FİYAT PRICE
MIBD36 135-195	1x35+16-1x95+16	865,00 ₺
MIBD36 1120-1240	1x120+16-1x240+25	1.075,00 ₺
MIBD36 1300-1400	1x300+25-1x400+35	1.435,00 ₺

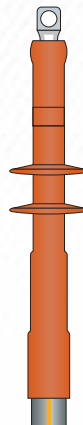

O.G. MEKANİK ÜÇ DAMARLI DAHİLİ ISI BÜZÜŞMELİ KABLO BAŞLIKLARI

M.V. BOLTED THREE CORES INDOOR HEAT SHRINKABLE CABLE TERMINATIONS



3.5-6 kV



5.8-10 kV

DAHİLİ

KOD CODE	KABLO KESİTİ CROSS SECTION	FİYAT PRICE
MIBD6 325-395	3x25+16-3x95+16	2.400,00 ₺
MIBD6 3120-3240	3x120+16-3x240+25	2.670,00 ₺
MIBD6 3300-3400	3x300+25-3x400+35	4.375,00 ₺

KOD CODE	KABLO KESİTİ CROSS SECTION	FİYAT PRICE
MIBD10 325-395	3x25+16-3x95+16	2.400,00 ₺
MIBD10 3120-3240	3x120+16-3x240+25	2.670,00 ₺
MIBD10 3300-3400	3x300+25-3x400+35	4.375,00 ₺

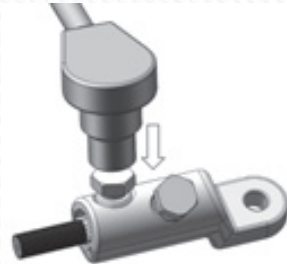

8.7-15 kV



20.8-36 kV

KOD CODE	KABLO KESİTİ CROSS SECTION	FİYAT PRICE
MIBD15 325-395	3x25+16-3x95+16	2.400,00 ₺
MIBD15 3120-3240	3x120+16-3x240+25	2.670,00 ₺
MIBD15 3300-3400	3x300+25-3x400+35	4.375,00 ₺

KOD CODE	KABLO KESİTİ CROSS SECTION	FİYAT PRICE
MIBD36 335-395	3x35+16-3x95+16	3315,00 ₺
MIBD36 3120-3240	3x120+16-3x240+25	3.680,00 ₺
MIBD36 3300-3400	3x300+25-3x400+35	5.090,00 ₺

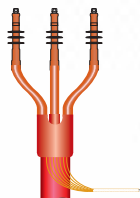
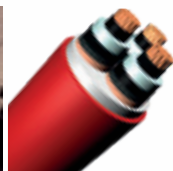



3.5-6 kV

KOD CODE	KABLO KESİTİ CROSS SECTION	FİYAT PRICE
SH6 125	1x25+16	415,00 ₺
SH6 135	1x35+16	415,00 ₺
SH6 150	1x50+16	415,00 ₺
SH6 170	1x70+16	445,00 ₺
SH6 195	1x95+16	445,00 ₺
SH6 1120	1x120+16	465,00 ₺
SH6 1150	1x150+25	465,00 ₺
SH6 1185	1x185+25	490,00 ₺
SH6 1240	1x240+25	490,00 ₺

5.8-10 kV



KOD CODE	KABLO KESİTİ CROSS SECTION	FİYAT PRICE
SH10 125	1x25+16	415,00 ₺
SH10 135	1x35+16	415,00 ₺
SH10 150	1x50+16	415,00 ₺
SH10 170	1x70+16	445,00 ₺
SH10 195	1x95+16	445,00 ₺
SH10 1120	1x120+16	465,00 ₺
SH10 1150	1x150+25	465,00 ₺
SH10 1185	1x185+25	490,00 ₺
SH10 1240	1x240+25	490,00 ₺

HARİCİ



8.7-15 kV

KOD CODE	KABLO KESİTİ CROSS SECTION	FİYAT PRICE
SH15 125	1x25+16	495,00 ₺
SH15 135	1x35+16	495,00 ₺
SH15 150	1x50+16	495,00 ₺
SH15 170	1x70+16	515,00 ₺
SH15 195	1x95+16	515,00 ₺
SH15 1120	1x120+16	560,00 ₺
SH15 1150	1x150+25	560,00 ₺
SH15 1185	1x185+25	610,00 ₺
SH15 1240	1x240+25	610,00 ₺

20.8-36 kV



KOD CODE	KABLO KESİTİ CROSS SECTION	FİYAT PRICE
SH36 125	1x25+16	770,00 ₺
SH36 135	1x35+16	770,00 ₺
SH36 150	1x50+16	825,00 ₺
SH36 170	1x70+16	825,00 ₺
SH36 195	1x95+16	925,00 ₺
SH36 1120	1x120+16	925,00 ₺
SH36 1150	1x150+25	960,00 ₺
SH36 1185	1x185+25	960,00 ₺
SH36 1240	1x240+25	1.090,00 ₺

HARİCİ

* Alüminyum iletkenli üretim yapılıır.

* Production of aluminium conductors are made



O.G. ÜÇ DAMARLI HARİCİ SİLİKON KABLO BAŞLIKLARI

M.V. THREE CORES OUTDOOR SILICONE CABLE TERMINATIONS



3.5-6 kV



5.8-10 kV

KOD CODE	KABLO KESİTİ CROSS SECTION	FİYAT PRICE
SH6 325	3x25+16	1.190,00 ₺
SH6 335	3x35+16	1.190,00 ₺
SH6 350	3x50+16	1.190,00 ₺
SH6 370	3x70+16	1.210,00 ₺
SH6 395	3x95+16	1.210,00 ₺
SH6 3120	3x120+16	1.245,00 ₺
SH6 3150	3x150+25	1.245,00 ₺
SH6 3185	3x185+25	1.265,00 ₺
SH6 3240	3x240+25	1.300,00 ₺

KOD CODE	KABLO KESİTİ CROSS SECTION	FİYAT PRICE
SH10 325	3x25+16	1.190,00 ₺
SH10 335	3x35+16	1.190,00 ₺
SH10 350	3x50+16	1.190,00 ₺
SH10 370	3x70+16	1.210,00 ₺
SH10 395	3x95+16	1.210,00 ₺
SH10 3120	3x120+16	1.245,00 ₺
SH10 3150	3x150+25	1.245,00 ₺
SH10 3185	3x185+25	1.265,00 ₺
SH10 3240	3x240+25	1.300,00 ₺

HARİCİ



8.7-15 kV



20.8-36 kV

KOD CODE	KABLO KESİTİ CROSS SECTION	FİYAT PRICE
SH15 325	3x25+16	1.390,00 ₺
SH15 335	3x35+16	1.390,00 ₺
SH15 350	3x50+16	1.390,00 ₺
SH15 370	3x70+16	1.430,00 ₺
SH15 395	3x95+16	1.430,00 ₺
SH15 3120	3x120+16	1.455,00 ₺
SH15 3150	3x150+25	1.455,00 ₺
SH15 3185	3x185+25	1.480,00 ₺
SH15 3240	3x240+25	1.520,00 ₺

KOD CODE	KABLO KESİTİ CROSS SECTION	FİYAT PRICE
SH36 325	3x25+16	2.400,00 ₺
SH36 335	3x35+16	2.400,00 ₺
SH36 350	3x50+16	2.565,00 ₺
SH36 370	3x70+16	2.565,00 ₺
SH36 395	3x95+16	2.820,00 ₺
SH36 3120	3x120+16	2.820,00 ₺
SH36 3150	3x150+25	2.860,00 ₺
SH36 3185	3x185+25	2.860,00 ₺
SH36 3240	3x240+25	3.230,00 ₺

HARİCİ





3.5-6 kV

KOD CODE	KABLO KESİTİ CROSS SECTION	FİYAT PRICE
SD6 125	1x25+16	305,00 ₺
SD6 135	1x35+16	305,00 ₺
SD6 150	1x50+16	305,00 ₺
SD6 170	1x70+16	315,00 ₺
SD6 195	1x95+16	315,00 ₺
SD6 1120	1x120+16	335,00 ₺
SD6 1150	1x150+25	335,00 ₺
SD6 1185	1x185+25	365,00 ₺
SD6 1240	1x240+25	405,00 ₺



5.8-10 kV

KOD CODE	KABLO KESİTİ CROSS SECTION	FİYAT PRICE
SD10 125	1x25+16	305,00 ₺
SD10 135	1x35+16	305,00 ₺
SD10 150	1x50+16	305,00 ₺
SD10 170	1x70+16	315,00 ₺
SD10 195	1x95+16	315,00 ₺
SD10 1120	1x120+16	335,00 ₺
SD10 1150	1x150+25	335,00 ₺
SD10 1185	1x185+25	365,00 ₺
SD10 1240	1x240+25	405,00 ₺

DAHİLİ



8.7-15 kV

KOD CODE	KABLO KESİTİ CROSS SECTION	FİYAT PRICE
SD15 125	1x25+16	330,00 ₺
SD15 135	1x35+16	330,00 ₺
SD15 150	1x50+16	330,00 ₺
SD15 170	1x70+16	335,00 ₺
SD15 195	1x95+16	335,00 ₺
SD15 1120	1x120+16	365,00 ₺
SD15 1150	1x150+25	365,00 ₺
SD15 1185	1x185+25	390,00 ₺
SD15 1240	1x240+25	470,00 ₺



20.8-36 kV

KOD CODE	KABLO KESİTİ CROSS SECTION	FİYAT PRICE
SD36 125	1x25+16	420,00 ₺
SD36 135	1x35+16	420,00 ₺
SD36 150	1x50+16	445,00 ₺
SD36 170	1x70+16	445,00 ₺
SD36 195	1x95+16	500,00 ₺
SD36 1120	1x120+16	500,00 ₺
SD36 1150	1x150+25	545,00 ₺
SD36 1185	1x185+25	545,00 ₺
SD36 1240	1x240+25	655,00 ₺

DAHİLİ



O.G. ÜÇ DAMARLI DAHİLİ SİLİKON KABLO BAŞLIKLARI

M.V. THREE CORES INDOOR SILICONE CABLE TERMINATIONS



3.5-6 kV



5.8-10 kV

KOD CODE	KABLO KESİTİ CROSS SECTION	FİYAT PRICE
SD6 325	3x25+16	695,00 ₺
SD6 335	3x35+16	695,00 ₺
SD6 350	3x50+16	695,00 ₺
SD6 370	3x70+16	745,00 ₺
SD6 395	3x95+16	745,00 ₺
SD6 3120	3x120+16	775,00 ₺
SD6 3150	3x150+25	775,00 ₺
SD6 3185	3x185+25	795,00 ₺
SD6 3240	3x240+25	835,00 ₺

DAHİLİ

KOD CODE	KABLO KESİTİ CROSS SECTION	FİYAT PRICE
SD10 325	3x25+16	695,00 ₺
SD10 335	3x35+16	695,00 ₺
SD10 350	3x50+16	695,00 ₺
SD10 370	3x70+16	745,00 ₺
SD10 395	3x95+16	745,00 ₺
SD10 3120	3x120+16	775,00 ₺
SD10 3150	3x150+25	775,00 ₺
SD10 3185	3x185+25	795,00 ₺
SD10 3240	3x240+25	835,00 ₺



8.7-15 kV



20.8-36 kV

KOD CODE	KABLO KESİTİ CROSS SECTION	FİYAT PRICE
SD15 325	3x25+16	945,00 ₺
SD15 335	3x35+16	945,00 ₺
SD15 350	3x50+16	945,00 ₺
SD15 370	3x70+16	995,00 ₺
SD15 395	3x95+16	995,00 ₺
SD15 3120	3x120+16	1.020,00 ₺
SD15 3150	3x150+25	1.020,00 ₺
SD15 3185	3x185+25	1.050,00 ₺
SD15 3240	3x240+25	1.080,00 ₺

DAHİLİ

KOD CODE	KABLO KESİTİ CROSS SECTION	FİYAT PRICE
SD36 325	3x25+16	1.570,00 ₺
SD36 335	3x35+16	1.570,00 ₺
SD36 350	3x50+16	1.590,00 ₺
SD36 370	3x70+16	1.590,00 ₺
SD36 395	3x95+16	1.750,00 ₺
SD36 3120	3x120+16	1.750,00 ₺
SD36 3150	3x150+25	1.790,00 ₺
SD36 3185	3x185+25	1.790,00 ₺
SD36 3240	3x240+25	2.055,00 ₺



TEK DAMARLI HARİCİ KABLO BAŞLIĞI SINGLE CORE OUTDOOR CABLE TERMINATIONS

KOD CODE	KABLO KESİTİ CROSS SECTION	FİYAT PRICE
TSH36 135	1x35+16	1.260,00 ₺
TSH36 150	1x50+16	1.260,00 ₺
TSH36 170	1x70+16	1.260,00 ₺
TSH36 195	1x95+16	1.260,00 ₺
TSH36 1120	1x120+16	1.455,00 ₺
TSH36 1150	1x150+25	1.455,00 ₺
TSH36 1185	1x185+25	1.455,00 ₺
TSH36 1240	1x240+25	1.455,00 ₺

H
A
R
İ
C
İ



TEK DAMARLI DAHİLİ KABLO BAŞLIĞI SINGLE CORE INDOOR CABLE TERMINATIONS

KOD CODE	KABLO KESİTİ CROSS SECTION	FİYAT PRICE
TSD36 135	1x35+16	900,00 ₺
TSD36 150	1x50+16	900,00 ₺
TSD36 170	1x70+16	900,00 ₺
TSD36 195	1x95+16	900,00 ₺
TSD36 1120	1x120+16	1.130,00 ₺
TSD36 1150	1x150+25	1.130,00 ₺
TSD36 1185	1x185+25	1.130,00 ₺
TSD36 1240	1x240+25	1.130,00 ₺

D
A
H
İ
L
İ



O.G. TESLA MODELİ (YEKPAE) SİLİKON KABLO BAŞLIKLARI

M.V. TESLA TYPE SILICONE CABLE TERMINATIONS

ÜÇ DAMARLI HARİCİ KABLO BAŞLIĞI THREE CORES OUTDOOR CABLE TERMINATIONS

20.8-36 kV

KOD CODE	KABLO KESİTİ CROSS SECTION	FİYAT PRICE
TSH36 335	3x35+16	4.040,00 ₺
TSH36 350	3x50+16	4.040,00 ₺
TSH36 370	3x70+16	4.040,00 ₺
TSH36 395	3x95+16	4.040,00 ₺
TSH36 3120	3x120+16	4.510,00 ₺
TSH36 3150	3x150+25	4.510,00 ₺
TSH36 3185	3x185+25	4.510,00 ₺
TSH36 3240	3x240+25	4.510,00 ₺



HARİCİ

ÜÇ DAMARLI DAHİLİ KABLO BAŞLIĞI THREE CORES INDOOR CABLE TERMINATIONS

20.8-36 kV

KOD CODE	KABLO KESİTİ CROSS SECTION	FİYAT PRICE
TSD36 335	3x35+16	3.390,00 ₺
TSD36 350	3x50+16	3.390,00 ₺
TSD36 370	3x70+16	3.390,00 ₺
TSD36 395	3x95+16	3.390,00 ₺
TSD36 3120	3x120+16	3.585,00 ₺
TSD36 3150	3x150+25	3.585,00 ₺
TSD36 3185	3x185+25	3.585,00 ₺
TSD36 3240	3x240+25	3.585,00 ₺



DAHİLİ



Silikon Kablo
Başlıkları

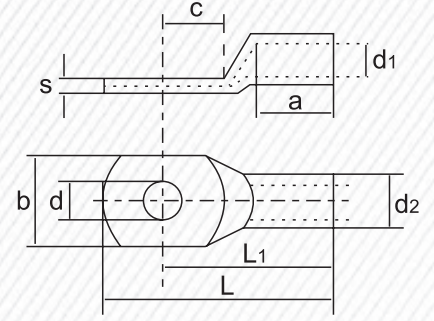

KOD CODE	KESİT CROSS SECTION	BAĞLANTI SCREW DIAMETER	KUTU / ADET UNIT / BOX	FİYAT PRICE	a (mm)	b (mm)	c (mm)	d (mm)	d1 (mm)	d2 (mm)	L (mm)	L1 (mm)	s (mm)
SKP 06	6 mm ²	M 6	1500	6,30 ₺	7,5	7,8	6,7	5,4	4,1	5,45	25,1	18,55	1,55
SKP 10	10 mm ²	M 6	1000	7,45 ₺	15	8,9	7,24	5,6	4,57	5,9	36,2	29,5	1,3
SKP 16	16 mm ²	M 8	400	9,65 ₺	20	12,9	13	8,6	6,5	8,55	51	44,2	1,8
SKP 25	25 mm ²	M 8	250	13,45 ₺	25	14,2	12	8,55	7	10	53,5	42,6	2,95
SKP 35	35 mm ²	M 10	200	19,10 ₺	25	17,1	10,5	10,5	8,8	11,48	58	46,7	2,38
SKP 50	50 mm ²	M 10	150	29,15 ₺	25	18,7	12,9	10,6	10,1	13	63,4	53,4	2,8
SKP 70	70 mm ²	M 12	100	35,30 ₺	27,8	21	12,71	13,5	11,7	14,48	71,2	55	2,88
SKP 95	95 mm ²	M 12	75	45,95 ₺	34	24,8	15,2	13,5	13,49	17,25	82,5	66	3,34
SKP 120	120 mm ²	M 12	50	61,00 ₺	33	26	15	13	14,35	18,14	83,7	67,8	3,46
SKP 150	150 mm ²	M 12	35	82,35 ₺	35	32	12,8	13	17,7	21,85	92,7	76,7	3,77
SKP 185	185 mm ²	M 16	25	90,15 ₺	39	33,6	16,7	17	18	23,1	99,3	80,1	3,8
SKP 240	240 mm ²	M 16	18	144,00 ₺	40	39,1	16,1	17	21,2	27	108	89	5,27
SKP 300	300 mm ²	M 20	14	190,00 ₺	48	43,4	20	21	24	30,12	120	100	5,87
SKP 400	400 mm ²	M 20	10	230,00 ₺	48	50	23	21	27,2	34,85	122	117,6	6,9

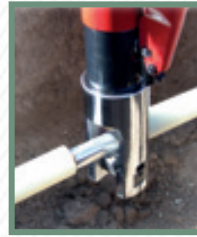
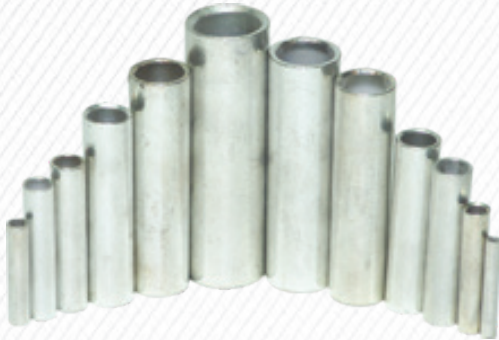

SIKMALI BAKIR EK MUFLARI

COMPRESSIVE COPPER CONNECTORS

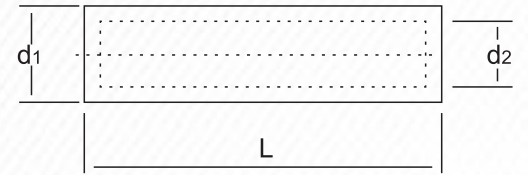

KOD CODE	KESİT CROSS SECTION	KUTU / ADET UNIT / BOX	FİYAT PRICE	L (mm)	d1 (mm)	d2 (mm)	d1-d2/2 (mm)
SEM 06	6 mm ²	1500	5,10 ₺	30,2	5,8	4,1	0,85
SEM 10	10 mm ²	1000	6,20 ₺	40,1	6,78	5,1	0,84
SEM 16	16 mm ²	400	7,30 ₺	42	8,25	6,7	0,775
SEM 25	25 mm ²	250	11,75 ₺	50	9,9	7,22	1,34
SEM 35	35 mm ²	200	14,55 ₺	52	11,37	9,1	1,135
SEM 50	50 mm ²	150	20,75 ₺	58	12,9	10	1,45
SEM 70	70 mm ²	100	26,90 ₺	61,5	14,3	11,5	1,4
SEM 95	95 mm ²	75	33,10 ₺	68	16,7	13,3	1,7
SEM 120	120 mm ²	50	45,35 ₺	70	19,4	15,5	1,95
SEM 150	150 mm ²	35	66,65 ₺	80	21,8	18	1,9
SEM 185	185 mm ²	25	80,00 ₺	84	22,9	18,6	2,15
SEM 240	240 mm ²	18	125,00 ₺	92	26,8	21,6	2,6
SEM 300	300 mm ²	14	166,50 ₺	101	30,3	24,4	2,95
SEM 400	400 mm ²	10	198,50 ₺	120	34	27	3,5
SEM 630	630 mm ²	5	412,00 ₺	140	43,8	34,8	4,5

SIKMALI ALÜMİNYUM KABLO PABUCU

COMPRESSIVE ALUMINIUM CABLE LUG

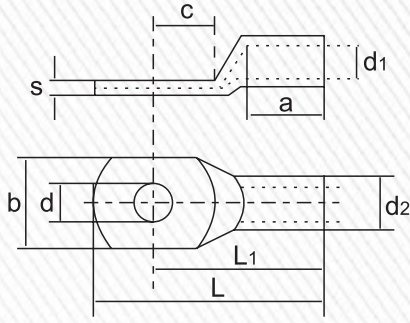

KOD CODE	KESİT CROSS SECTION	BAĞLANTI SCREW DIAMETER	KUTU / ADET UNIT / BOX	FİYAT PRICE	a (mm)	b (mm)	c (mm)	d (mm)	d1 (mm)	d2 (mm)	L (mm)	L1 (mm)	s (mm)
ASKP 16	16 mm ²	M6	400	7,40 ₺	20	13	7,5	6,5	6	10	56	48,5	4
ASKP 25	25 mm ²	M6	250	9,55 ₺	20	15	9	8,5	7	12	62	53	4,5
ASKP 35	35 mm ²	M6	200	13,20 ₺	20	19	10	10,5	8,2	14	75	63	5
ASKP 50	50 mm ²	M8	150	17,00 ₺	28	22	11,5	10,5	10	16	80	69,5	5,5
ASKP 70	70 mm ²	M8	100	21,20 ₺	28	24	12,5	10,5	12	18	95	81,5	6
ASKP 95	95 mm ²	M10	75	35,30 ₺	35	28	13,5	13	13,5	22	102	88,5	8,5
ASKP 120	120 mm ²	M10	50	45,40 ₺	35	32	16	13	16	23	112	96	6,5
ASKP 150	150 mm ²	M12	35	51,35 ₺	35	34	17,5	13	17	26	114	96,5	8
ASKP 185	185 mm ²	M12	25	62,35 ₺	40	37	19	15	18,5	28	125	106	8
ASKP 240	240 mm ²	M12	18	85,70 ₺	40	42	20	17	22	32	141,5	121,5	10,5
ASKP 300	300 mm ²	M16	8	108,70 ₺	76	46,5	31,5	17	23,5	34	142,5	118	10,6
ASKP 400	400 mm ²	M20	5	173,00 ₺	115	50,6	33,5	21	25	36	190	160	9,8
ASKP 500	500 mm ²	M20	5	222,00 ₺	115	-	-	21	-	-	190	160	-

SIKMALI ALÜMİNYUM KABLO EK MUFLARI

COMPRESSIVE ALUMINIUM CABLE CONNECTORS

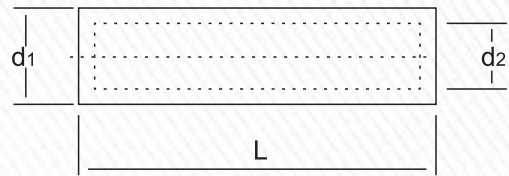

KOD CODE	KESİT CROSS SECTION	KUTU / ADET UNIT / BOX	FİYAT PRICE	L (mm)	d1 (mm)	d2 (mm)	d1-d2/2 (mm)
ASEM 16	16 mm ²	400	6,30 ₺	60	10	5,6	2,2
ASEM 25	25 mm ²	250	8,40 ₺	70	11,5	7	2,25
ASEM 35	35 mm ²	200	11,75 ₺	76	14	8,2	2,9
ASEM 50	50 mm ²	150	16,25 ₺	83	16	10	3
ASEM 70	70 mm ²	100	20,85 ₺	97	18	11,5	3,25
ASEM 95	95 mm ²	75	24,65 ₺	109	21	13,5	3,75
ASEM 120	120 mm ²	50	30,25 ₺	109	22	15	3,5
ASEM 150	150 mm ²	35	44,25 ₺	118,5	25	16,5	4,25
ASEM 185	185 mm ²	25	59,35 ₺	125,5	28	18,5	4,75
ASEM 240	240 mm ²	18	83,00 ₺	141,5	32	21,2	5,4
ASEM 300	300 mm ²	12	105,30 ₺	143	34	24,5	4,75
ASEM 400	400 mm ²	10	141,10 ₺	150	36	25	5,5
ASEM 500	500 mm ²	5	236,00 ₺	162	40	27,5	6,25

DIN NORM SIKMALI KABLO PABUCU

DIN NORM COMPRESSIVE LUG

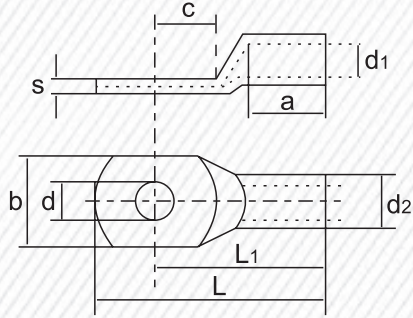

KOD CODE	KABLO KESİTİ CROSS SECTION	BAĞLANTI SCREW DIAMETER	FİYAT PRICE	KUTU/ADET UNIT/BOX	a (mm)	b (mm)	c1 (mm)	d (mm)	d1 (mm)	d2 (mm)	L (mm)	L1 (mm)
SKPD 10	10 mm ²	M 6	7,85 ₺	1000	10	9	7,5	6,4	4,5	6	27	34,5
SKPD 16	16 mm ²	M 8	17,20 ₺	400	20	13	10	8,4	5,5	8,5	36	46
SKPD 25	25 mm ²	M 8	24,00 ₺	250	20	16	10	8,4	7	10	38	48
SKPD 35	35 mm ²	M 10	41,60 ₺	200	20	19	12	10,5	8,2	12,5	42	54
SKPD 50	50 mm ²	M 10	64,00 ₺	150	28	22	12	10,5	10	14,5	52	64
SKPD 70	70 mm ²	M 12	91,00 ₺	100	28	24	13	13	11,5	16,5	55	68
SKPD 95	95 mm ²	M 12	116,00 ₺	75	35	28	13	13	13,5	19	65	78
SKPD 120	120 mm ²	M 12	151,00 ₺	50	35	32	16	13	15,5	21	70	86
SKPD 150	150 mm ²	M 12	176,00 ₺	35	35	34	16	13	17	23,5	78	94
SKPD 185	185 mm ²	M 16	258,00 ₺	25	40	37	19	17	19	25,5	82	101
SKPD 240	240 mm ²	M 16	342,00 ₺	18	40	42	19	17	21,5	29	92	111

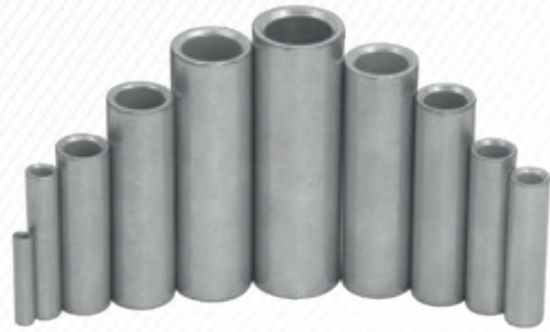
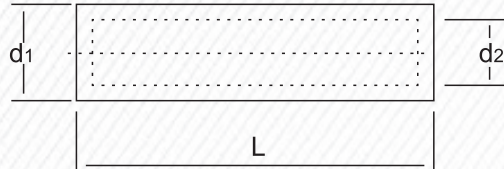

DIN NORM SIKMALI EK MUFLARI

DIN NORM COMPRESSIVE CONNECTORS

KOD CODE	KABLO KESİTİ CROSS SECTION	FİYAT PRICE	KUTU/ADET UNIT/BOX	L (mm)	d1 (mm)	d2 (mm)	D1-D2/2 (mm)
SEMD 10	10	7,00 ₺	1000	30,8	4,5	6	0,75
SEMD 16	16	19,00 ₺	400	50	5,5	8,5	1,5
SEMD 25	25	24,00 ₺	250	50	7	10	1,5
SEMD 35	35	42,00 ₺	200	50	8,2	12,5	2,15
SEMD 50	50	61,40 ₺	150	56	10	14,5	2,25
SEMD 70	70	71,00 ₺	100	56	11,5	16,5	2,5
SEMD 95	95	108,00 ₺	75	70	13,5	19	2,75
SEMD 120	120	118,00 ₺	50	70	15,5	21	2,75
SEMD 150	150	176,00 ₺	35	80	17	23,5	3,25
SEMD 185	185	198,00 ₺	25	85	19	25,5	3,25
SEMD 240	240	286,00 ₺	18	90	21,5	29	3,75

BİMETAL SIKMALI KABLO PABUCU

BIMETAL COMPRESSIVE LUG

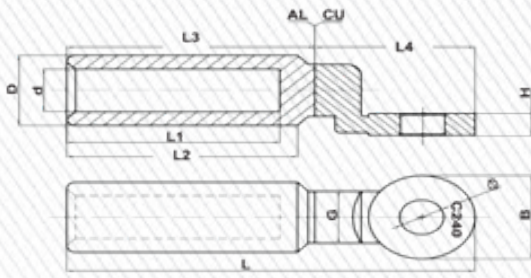

KOD CODE	KESİT CROSS SECTION	BAĞLANTI SCREW DIAMETER	FİYAT PRICE	D (mm)	d (mm)	L±2 (mm)	L1±1 (mm)	L2±1.5 (mm)	L3 (mm)	L4 (mm)	B (mm)	H (mm)
BTSKP 16	16 mm ²	M 8	4,70 \$	16	5,5	82	38	48	52	30	20	4
BTSKP 25	25 mm ²	M 8	4,70 \$	16	6,5	82	38	48	52	30	20	4
BTSKP 35	35 mm ²	M 8	4,70 \$	16	8,2	82	38	48	52	30	20	4
BTSKP 50	50 mm ²	M 10	5,60 \$	20	9,7	88	43	48	52	36	24	5
BTSKP 70	70 mm ²	M 10	5,60 \$	20	11	88	43	48	52	36	24	5
BTSKP 95	95 mm ²	M 10	5,60 \$	20	12,5	88	43	48	52	36	24	5
BTSKP 120	120 mm ²	M 12	9,00 \$	25	13,7	110	60	64	68	44	30	6
BTSKP 150	150 mm ²	M 12	9,00 \$	25	15,5	110	60	64	68	44	30	6
BTSKP 185	185 mm ²	M 12	14,50 \$	32	17,5	120	60	64	70	50	35	8
BTSKP 240	240 mm ²	M 12	14,50 \$	32	19,5	120	60	64	70	50	35	8
BTSKP 300	300 mm ²	M 12	26,50 \$	40	23	160	93	101	108	52	36	8
BTSKP 400	400 mm ²	M 12	26,50 \$	40	26,2	160	93	101	108	52	36	8

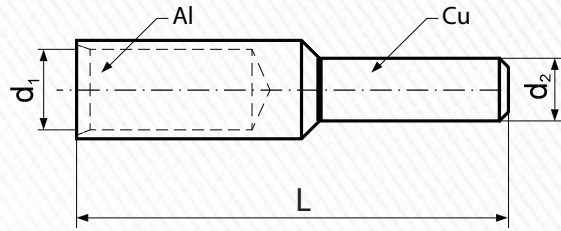

BİMETAL SIKMALI EK MUF

BIMETALLIC COMPRESSIVE CONNECTORS

KOD CODE	KESİT CROSS SECTION	FİYAT PRICE	d1 (mm)	d2 (mm)	L (mm)
BTSEM 35-16	35-16 mm ²	2,60 \$	8,5	7,0	85,0
BTSEM 50-25	50-25 mm ²	3,50 \$	9,8	8,5	90,0
BTSEM 70-35	70-35 mm ²	4,50 \$	11,5	9,8	100,0
BTSEM 95-50	95-50 mm ²	7,00 \$	13,5	11,5	110,0
BTSEM 120-70	120-70 mm ²	8,00 \$	15,0	13,5	110,0
BTSEM 150-95	150-95 mm ²	9,00 \$	16,5	15,0	115,0
BTSEM 185-120	185-120 mm ²	12,00 \$	18,5	16,5	125,0
BTSEM 240-150	240-150 mm ²	18,00 \$	21,0	18,5	130,0



BİMETAL PIN

BIMETALLIC PIN



KOD CODE	KESİT CROSS SECTION	FİYAT PRICE
BTPIN 10	10 mm	3,00 \$
BTPIN 16	16 mm	3,00 \$
BTPIN 25	25 mm	3,75 \$
BTPIN 35	35 mm	5,00 \$
BTPIN 50	50 mm	7,50 \$
BTPIN 70	70 mm	8,00 \$
BTPIN 95	95 mm	9,00 \$
BTPIN 120	120 mm	10,00 \$
BTPIN 150	150 mm	10,50 \$
BTPIN 185	185 mm	12,50 \$
BTPIN 240	240 mm	18,50 \$
BTPIN 300	300 mm	22,50 \$

MEKANİK SIKMALI EK MUF BOLTED CONNECTOR

KOD CODE	FİYAT PRICE	KABLO KESİTİ CROSS SECTION (mm ²)	DIŞ ÇAP OUTER D. (mm)	VİDA SAYISI BOLT NUMBER	KUTU/ADET UNIT/BOX
MSEM 25-95/2	35,00 \$	25-95	24	2	40
MSEM 35-150/4	38,00 \$	35-150	28	4	20
MSEM 70-240/4	47,00 \$	70-240	33	4	15
MSEM 120-300/4	59,00 \$	120-300	38	4	10
MSEM 185-400/4	65,00 \$	185-400	42	4	9
MSEM 500-630/6	128,00 \$	500-630	52	6	4



MEKANİK SIKMALI KABLO PABUCU BOLTED LUG

KOD CODE	FİYAT PRICE	KABLO KESİTİ CROSS SECTION (mm ²)	DIŞ ÇAP OUTER D. (mm)	VİDA SAYISI BOLT NUMBER	KUTU/ADET UNIT/BOX
MSKP 25-95-12/2	26,00 \$	25-95	24	2	40
MSKP 35-150-12/2	29,00 \$	35-150	28	2	20
MSKP 70-240-12/2	39,00 \$	70-240	33	2	12
MSKP 120-300-16/2	56,00 \$	120-300	38	2	9
MSKP 185-400-16/2	60,00 \$	185-400	42	2	7



BİMETAL MEKANİK SIKMALI KABLO PABUCU BIMETALLIC BOLTED LUG

KOD CODE	FİYAT PRICE	KABLO KESİTİ CROSS SECTION (mm ²)	DIŞ ÇAP OUTER D. (mm)	VİDA SAYISI BOLT NUMBER	KUTU/ADET UNIT/BOX
BMSKP 35-150-12/2	39,00 \$	35-150	28	2	80
BMSKP 70-240-12/2	48,00 \$	70-240	33	2	48
BMSKP 120-300-12/2	63,00 \$	120-300	38	2	36
BMSKP 185-400-16/2	108,00 \$	185-400	42	2	28



VİDALI KLEMENSLER SCREWED CONNECTORS

KOD CODE	KABLO KESİTİ CROSS SECTION (mm ²)	UZUNLUK LENGTH (mm)	ÇAP DIAMETER (mm)	FİYAT PRICE
VK 01	1,5 - 6	28	4,5	6,30 ₺
VK 02	10 - 16	50	5,5	9,00 ₺
VK 03	25	50	7	13,00 ₺
VK 04	35	56	8,5	16,50 ₺
VK 05	50	55	10	20,50 ₺
VK 06	70	60	12	23,50 ₺

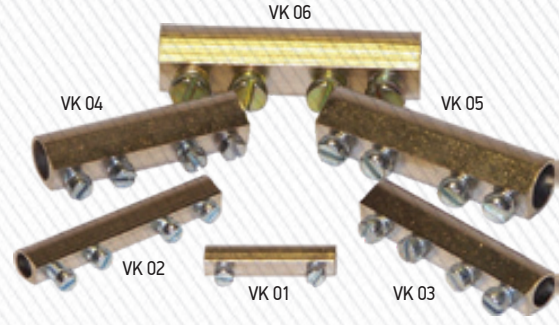

C- H KLEMENSLER C - H TYPE CONNECTORS

KOD CODE	KABLO KESİTİ CROSS SECTION (mm ²)	UZUNLUK LENGTH (mm)	ÇAP DIAMETER (mm)	FİYAT PRICE
CK 01	6 - 10 - 16	18	12	38,00 ₺
CK 02	25 - 35	27	20	54,50 ₺
CK 03	50 - 70 - 95	32	25	69,50 ₺
HK 01	50 - 95	30	22	80,00 ₺



SERFİL KLEMENSLER SERFIL CONNECTORS

KOD CODE	KABLO KESİTİ CROSS SECTION (mm ²)	UZUNLUK LENGTH (mm)	ÇAP DIAMETER (mm)	FİYAT PRICE
SK 16	16	25	3	31,50 ₺
SK 25	25	26	4	36,50 ₺
SK 35	35	28,5	5	38,00 ₺
SK 50	50	30	8	40,50 ₺
SK 70	70	32,5	8	57,50 ₺
SK 95	95	34,5	11	59,50 ₺
SK 120	120	38	12	63,00 ₺
SK 150	150	42	11	84,00 ₺
SK 185	185	48	16	111,50 ₺
SK 240	240	53	20	148,00 ₺



AG REÇİNELİ YALITIM BORULARI L.V. WITH ADHESIVE INSULATION TUBES



KOD CODE	(a) DARALMA ÖNCESİ BEFORE EXPANDED (mm) Φ	(b) DARALMA SONRASI AFTER EXPANDED (mm) Φ	(L) UZUNLUK LENGTH (m)	FIYAT PRICE (m/₺)
TIB 9/3	9	3	1,2	26,00 ₺
TIB 12/4	12	4	1,2	38,00 ₺
TIB 16/5	16	5	1,2	56,00 ₺
TIB 22/6	22	6	1,2	76,15 ₺
TIB 25/8	25	8	1,2	89,50 ₺
TIB 33/10	33	10	1,2	92,00 ₺
TIB 40/12	40	12	1,2	97,50 ₺
TIB 45/15	45	15	1,2	124,00 ₺
TIB 54/18	54	18	1,2	127,00 ₺
TIB 65/22	65	22	1,2	174,00 ₺
TIB 75/22	75	22	1,2	177,00 ₺
TIB 80/30	80	30	1,2	224,00 ₺
TIB 90/30	90	30	1,2	230,00 ₺
TIB 105/33	105	33	1,2	258,00 ₺
TIB 125/40	130	40	1,5	301,00 ₺
TIB 140/40	140	40	1,5	347,00 ₺
TIB 150/50	150	50	1,5	566,00 ₺
TIB 170/58	170	58	1,5	616,00 ₺



OG BARA İZOLASYON BORULARI M.V. BUSBAR INSULATION TUBES



KOD CODE	(a) DARALMA ÖNCESİ BEFORE EXPANDED (mm) Ø	(b) DARALMA SONRASI AFTER EXPANDED (mm) Ø	(L) UZUNLUK LENGTH (m)	FİYAT PRICE (m/₺)
TAIB 21/7	21	7	1,2 veya (25m/rulo)	270,00 ₺
TAIB 33/10	33	10	1,2 veya (25m/rulo)	310,00 ₺
TAIB 38/12	38	12	1,2 veya (25m/rulo)	326,00 ₺
TAIB 45/17	45	17	1,2 veya (25m/rulo)	382,00 ₺
TAIB 54/18	54	18	1,2 veya (25m/rulo)	395,00 ₺
TAIB 60/22	60	22	1,2 veya (25m/rulo)	395,00 ₺
TAIB 65/22	65	22	1,2	395,00 ₺
TAIB 75/22	75	22	1,2	395,00 ₺
TAIB 90/30	90	30	1,2	470,00 ₺
TAIB 110/40	110	40	1,2	545,00 ₺
TAIB 125/40	125	40	1,2	545,00 ₺
TAIB 140/40	140	40	1,5	545,00 ₺
TAIB 160/50	160	50	1,5	870,00 ₺

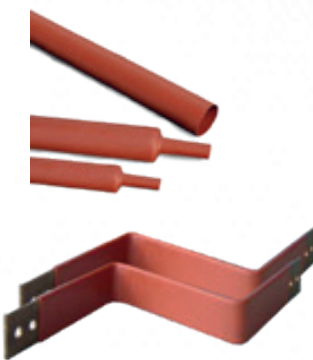



KOD CODE	(a) DARALMA ÖNCESİ BEFORE EXPANDED (mm) Φ	(b) DARALMA SONRASI AFTER EXPANDED (mm) Φ	(L) UZUNLUK LENGTH (m)	FİYAT PRICE (m/\$)
TFB 38/12	38	12	1	51,00 \$
TFB 50/18	50	18	1	55,00 \$
TFB 65/22	65	22	1	62,00 \$
TFB 80/30	80	30	1	67,00 \$
TFB 100/35	100	35	1	74,00 \$
TFB 120/40	120	40	1	79,00 \$

UÇ KORUYUCULAR

END CAPS

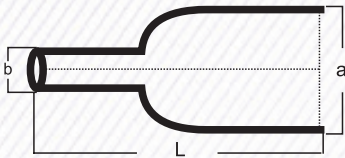

KOD CODE	(a) DARALMA ÖNCESİ BEFORE EXPANDED (mm) Φ	(b) DARALMA SONRASI AFTER EXPANDED (mm) Φ	(L) UZUNLUK LENGTH (mm)	FİYAT PRICE
UK 11/5	11	5,5	22	29,00 ₺
UK 16/7	16	7,5	75	36,00 ₺
UK 25/10	25	10,5	80	39,00 ₺
UK 32/16	32	16,5	90	45,00 ₺
UK 50/26	50	26	115	55,00 ₺
UK 70/37	70	37	120	71,00 ₺
UK 100/46	100	46	140	84,00 ₺
UK 120/57	120	57	155	98,00 ₺



Isı Büzüşmeli İzolasyon Boruları



ANA KOD MAIN CODE	KOD CODE	Siyah Black (m/\$)	KOD CODE	Sarı- Yeşil Yellow/ Green (m/\$)	KOD CODE	Kırmızı Red (m/\$)	KOD CODE	Sarı Yellow (m/\$)	KOD CODE	Mavi Blue (m/\$)	KOD CODE	Yeşil Green (m/\$)
MAK 1,5	MAK 01.511	0,075	MAK 01.512	0,3595	MAK 01.513	0,0886	MAK 01.514	0,0886	MAK 01.515	0,0886	MAK 01.516	0,0886
MAK 2,5	MAK 02.511	0,110	MAK 02.512	0,3234	MAK 02.513	0,1300	MAK 02.514	0,1300	MAK 02.515	0,1300	MAK 02.516	0,1300
MAK 3,5	MAK 03.511	0,123	MAK 03.512	0,2268	MAK 03.513	0,1535	MAK 03.514	0,1535	MAK 03.515	0,1535	MAK 03.516	0,1535
MAK 4,5	MAK 04.511	0,159	MAK 04.512	0,2640	MAK 04.513	0,1955	MAK 04.514	0,1955	MAK 04.515	0,1955	MAK 04.516	0,1955
MAK 5	MAK 05.011	0,177	MAK 05.012	0,2820	MAK 05.013	0,2168	MAK 05.014	0,2168	MAK 05.015	0,2168	MAK 05.016	0,2168
MAK 6	MAK 06.011	0,210	MAK 06.012	0,3593	MAK 06.013	0,2515	MAK 06.014	0,2515	MAK 06.015	0,2515	MAK 06.016	0,2515
MAK 7	MAK 07.011	0,220	MAK 07.012	0,3450	MAK 07.013	0,2732	MAK 07.014	0,2732	MAK 07.015	0,2732	MAK 07.016	0,2732
MAK 8	MAK 08.011	0,238	MAK 08.012	0,3965	MAK 08.013	0,2898	MAK 08.014	0,2898	MAK 08.015	0,2898	MAK 08.016	0,2898
MAK 10	MAK 1011	0,292	MAK 1012	0,4950	MAK 1013	0,3583	MAK 1014	0,3583	MAK 1015	0,3583	MAK 1016	0,3583
MAK 12	MAK 1211	0,336	MAK 1212	0,6085	MAK 1213	0,4132	MAK 1214	0,4132	MAK 1215	0,4132	MAK 1216	0,4132
MAK 13	MAK 1311	0,347	MAK 1312	0,7015	MAK 1313	0,4224	MAK 1314	0,4224	MAK 1315	0,4224	MAK 1316	0,4224
MAK 16	MAK 1611	0,568	MAK 1612	0,9790	MAK 1613	0,6839	MAK 1614	0,6839	MAK 1615	0,6839	MAK 1616	0,6839
MAK 18	MAK 1811	0,745	MAK 1812	1,0900	MAK 1813	0,9017	MAK 1814	0,9017	MAK 1815	0,9017	MAK 1816	0,9017
MAK 2011	MAK 2011	0,933	MAK 2012	1,8605	MAK 2013	1,1215	MAK 2014	1,1215	MAK 2015	1,1215	MAK 2016	1,1215
MAK 2211	MAK 2211	1,138	MAK 2212	1,6085	MAK 2213	1,3773	MAK 2214	1,3773	MAK 2215	1,3773	MAK 2216	1,3773
MAK 25	MAK 2511	1,223	MAK 2512	1,8335	MAK 2513	1,4776	MAK 2514	1,4776	MAK 2515	1,4776	MAK 2516	1,4776
MAK 28	MAK 2811	1,647	MAK 2812	2,1000	MAK 2813	1,9950	MAK 2814	1,9950	MAK 2815	1,9950	MAK 2816	1,9950
MAK 30	MAK 3011	1,660	MAK 3012	2,4610	MAK 3013	2,0304	MAK 3014	2,0304	MAK 3015	2,0304	MAK 3016	2,0304
MAK 32	MAK 3211	2,100	MAK 3212	2,9420	MAK 3213	2,7917	MAK 3214	2,7917	MAK 3215	2,7917	MAK 3216	2,7917
MAK 35	MAK 3511	2,100	MAK 3512	3,0250	MAK 3513	2,9400	MAK 3514	2,9400	MAK 3515	2,9400	MAK 3516	2,9400
MAK 38	MAK 3811	2,300	MAK 3812	3,4650	MAK 3813	3,0402	MAK 3814	3,0402	MAK 3815	3,0402	MAK 3816	3,0402
MAK 40	MAK 4011	2,300	MAK 4012	3,4650	MAK 4013	3,3095	MAK 4014	3,3095	MAK 4015	3,3095	MAK 4016	3,3095
MAK 45	MAK 4511	2,850	MAK 4512	4,3610	MAK 4513	3,5935	MAK 4514	3,5935	MAK 4515	3,5935	MAK 4516	3,5935
MAK 50	MAK 5011	3,000	MAK 5012	4,7460	MAK 5013	4,0125	MAK 5014	4,0125	MAK 5015	4,0125	MAK 5016	4,0125
MAK 60	MAK 6011	3,800	MAK 6012	6,6220	MAK 6013	4,9945	MAK 6014	4,9945	MAK 6015	4,9945	MAK 6016	4,9945
MAK 70	MAK 7011	5,110	MAK 7012	8,9370	MAK 7013	6,7520	MAK 7014	6,7520	MAK 7015	6,7520	MAK 7016	6,7520
MAK 80	MAK 8011	5,650	MAK 8012	10,9000	MAK 8013	7,6595	MAK 8014	7,6595	MAK 8015	7,6595	MAK 8016	7,6595
MAK 90	MAK 9011	6,400	MAK 9012	13,8255	MAK 9013	8,7555	MAK 9014	8,7555	MAK 9015	8,7555	MAK 9016	8,7555
MAK 100	MAK 10011	7,000	MAK 10012	16,7000	MAK 10013	10,6500	MAK 10014	10,6500	MAK 10015	10,6500	MAK 10016	10,6500
MAK 120	MAK 12011	10,000	MAK 12012	21,0500	MAK 12013	14,4650	MAK 12014	14,4650	MAK 12015	14,4650	MAK 12016	14,4650
MAK 150	MAK 15011	14,200	MAK 15012	29,1000	MAK 15013	18,6585	MAK 15014	18,6585	MAK 15015	18,6585	MAK 15016	18,6585



ISI BÜZÜŞMELİ MAKARONLAR

HEAT SHRINKABLE THIN WALL TUBES

KOD CODE	Gri Grey (m/\$)	KOD CODE	Kahve Brown (m/\$)	DARALMA ÖNCESİ Before Expanded (mm)	DARALMA SONRASI After Expanded (mm)	BARAYA UYGUNLUK Busbar Eligibility	KABLOYA UYGUNLUK Cable Eligibility (1kV NYY Kablolar içindir -For NYY Cables)	Kablo Pabucuna Uygunluk Cable Lug Eligibility	PAKET Rulo Packing (m)
MAK 01.517	0,0886	MAK 01.518	0,0886	1,5	0,75				200
MAK 02.517	0,1300	MAK 02.518	0,1300	2,5	1,25				200
MAK 03.517	0,1535	MAK 03.518	0,1535	3,5	1,75				200
MAK 04.517	0,1955	MAK 04.518	0,1955	4,5	2,25				100
MAK 05.017	0,2168	MAK 05.018	0,2168	5	2,5				100
MAK 06.017	0,2515	MAK 06.018	0,2515	6	3				100
MAK 07.017	0,2732	MAK 07.018	0,2732	7	3,5				100
MAK 08.017	0,2898	MAK 08.018	0,2898	8	4				100
MAK 1017	0,3583	MAK 1018	0,3583	10	5			6-10	100
MAK 1217	0,4132	MAK 1218	0,4132	12	6		1x10,1x16	6-10	100
MAK 1317	0,4224	MAK 1318	0,4224	13	6,5	12X2-15X2-15X3	1x10,1x16,1x25,	16-25	100
MAK 1617	0,6839	MAK 1618	0,6839	16	8	20X2-20X3	1x16,1x25,1x35,1x50	16-25-35-50	100
MAK 1817	0,9017	MAK 1818	0,9017	18	9	20X5	1x25,1x35,1x50,1x70	35-50	100
MAK 2017	1,1215	MAK 2018	1,1215	20	10	20X5-25X3-25X5	1x25,1x35,1x50,1x70,1x95,2x10,3x10	70	100
MAK 2217	1,3773	MAK 2218	1,3773	22	11	25X5-30X3-30X5	1x35,1x50,1x70,1x95,1x120,2x10,2x16,,3x10,3x16,4x10	70-95	100
MAK 2517	1,4776	MAK 2518	1,4776	25	12,5	25X5-30X3-30X5	1x50,1x70,1x95,1x120,1x150,1x185,2x10, 2x16,2x25,3x10,3x16,4x10,4x16	70-95	50
MAK 2817	1,9950	MAK 2818	1,9950	28	14	40X3	1x95,1x120,1x150,2x10,2x16,2x25,2x35,3x10, 3x16,3x25,3x35,4x10,4x16,4x25	70-95	50
MAK 3017	2,0304	MAK 3018	2,0304	30	15	40X3-40X5	1x95,1x120,1x150,1x185,1x240,2x10,2x16,2x25,2x35, 2x50,3x10,3x16,3x25,3x35,3x50,4x10,4x16,4x25	120	50
MAK 3217	2,7917	MAK 3218	2,7917	32	16	30X10-40X5	1x95,1x120,1x150,1x185,1x240,1x300,2x16,2x25,2x35, 2x50,2x70,3x16,3x25,3x35,3x50,4x10,4x16,4x25,4x35	120-150	50
MAK 3517	2,9400	MAK 3518	2,9400	35	17,5	30X10-40X5- 40X10	1x120,1x150,1x185,1x240,1x300,2x16,2x25,2x35, 2x50,2x70,3x16,3x25,3x35,3x70,4x10,4x16,4x25,4x35,4x50	150	50
MAK 3817	3,0402	MAK 3818	3,0402	38	19	40X5-40X10	1x150,1x185,1x240,1x300,1x400,2x25,2x35, 2x50,2x70,2x95,3x25,3x35,3x50,4x16,4x25	185-240	50
MAK 4017	3,3095	MAK 4018	3,3095	40	20	50X5	1x185,1x240,1x300,2x25,2x35,2x50,2x70,2x95,3x25, 3x35,3x50,3x70,3x95,4x16,4x25,4x35,4x50,4x70	185-240-300	50
MAK 4517	3,5935	MAK 4518	3,5935	45	22,5	50X5-50X10	1x240,1x300,1x400,2x35,2x50,2x70,2x95,2x120,2x150,3x25, 3x35,3x50,3x70,3x95,3x120,4x25,4x35,4x50,4x70,4x95	240-300-400	25
MAK 5017	4,0125	MAK 5018	4,0125	50	25	60X5-60X10	1x240,1x300,1x400,2x50,2x70,2x95,2x120,2x150,2x185, 3x50,3x70,3x95,3x150,4x35,4x50,4x70,4x95,4x120	400	25
MAK 6017	4,9945	MAK 6018	4,9945	60	30	80X5-80X10	1x400,2x95,2x120,2x150,2x185,2x240,3x70,3x95,3x120, 3x150,3x185,3x240,4x50,4x70,4x95,4x120,4x150,4x185		25
MAK 7017	6,7520	MAK 7018	6,7520	70	35	100X5-100X10	2x120,2x150,2x185,2x240,2x300,3x95,3x120,3x150,3x185, 3x240,3x300,4x70,4x95,4x120,4x150,4x185,4x240		25
MAK 8017	7,6595	MAK 8018	7,6595	80	40	100X5-100X10	2x150,2x185,2x240,2x300,3x120,3x150,3x185,3x240, 3x300,3x400,4x95,4x120,4x150,4x185,4x240,4x300		25
MAK 9017	8,7555	MAK 9018	8,7555	90	45	100X10	2x185,2x240,2x300,3x185,3x240,3x300, 3x400,4x150,4x185,4x240,4x300,4x400		25
MAK 10017	10,6500	MAK 10018	10,6500	100	50	120X10	2x240,2x300,3x240,3x300,3x400,4x185,4x240,4x300,4x400		25
MAK 12017	14,4650	MAK 12018	14,4650	120	60	120X10-160X10	3x300,3x400,4x240,4x300,4x400		25
MAK 15017	18,6585	MAK 15018	18,6585	150	75	160X10	4x400		25

ÖZEL BANTLAR
SPECIAL TAPES



KOD CODE	ÇİNSİ TYPE	KALINLIK THICKNES (mm)	EN WIDTH (mm)	UZUNLUK LENGTH (m)	KUTU / ADET UNIT / BOX	FİYAT PRICE
PB 131910	Plastik Bant (0,6kV)	0,13	19	10	500	0,80 \$
PB 131925	Plastik Bant (0,6kV)	0,13	19	25	60	2,10 \$
PB 135025	Plastik Bant (0,6kV)	0,13	50	25	80	4,90 \$
TE 1401	Eriyen Bant (10kV)	0,76	19	8	60	4,90 \$
TE 1402	Eriyen Bant (10kV)	0,76	50	8	24	12,50 \$
TE 1403	Eriyen Bant (36kV)	0,76	19	9	60	13,00 \$
YİB 01	Yarı İletken Bant	0,75	19	5	96	16,50 \$

KOD CODE	ÇİNSİ TYPE	FİYAT PRICE
HYK 63	63 mm Huni Yan Kapak	10,95 ₺
HYK 75	75 mm Huni Yan Kapak	22,00 ₺
HYK 90	90 mm Huni Yan Kapak	44,00 ₺
HYK 100	100 mm Huni Yan Kapak	55,00 ₺
HYK 125	125 mm Huni Yan Kapak	66,00 ₺
KBH 01	Kablo Başlığı Hunisi	22,00 ₺
KBH 02	Kablo Başlığı Hunisi	28,00 ₺
KBH 03	Kablo Başlığı Hunisi	33,00 ₺
EMH 4205	4x2,5 -4x6 Ek Muf Hunisi (Takım)	33,00 ₺
EMH 63	4x10-4x16 Ek Muf Hunisi (Takım)	66,00 ₺
EMH 64	3x25+16- 3x50+25 Ek Muf Hunisi (Takım)	66,00 ₺
EMH 70 - 95	70-95mm Ek Muf Hunisi (Takım)	85,00 ₺
EMH 120-150	120-150mm Ek Muf Hunisi (Takım)	134,00 ₺
EMH 185-240	185-240mm Ek Muf Hunisi (Takım)	177,00 ₺

PLASTİK HUNİ KALIPLARI
PLASTIC FUNNEL MOULDS

EK MUF KALIPLARI
JOINT MOULDS

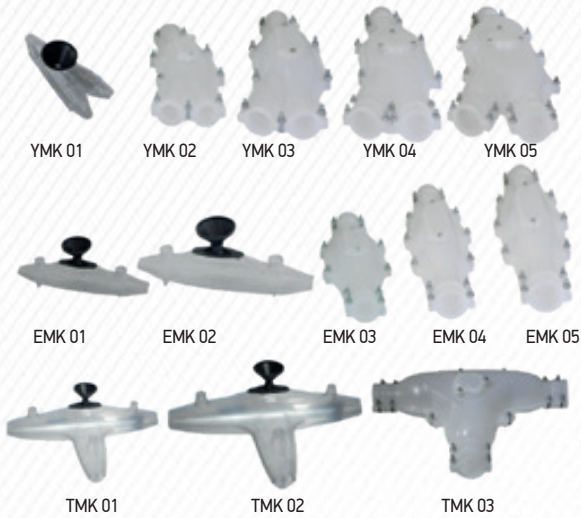
KOD CODE	ÇİNSİ TYPE	Uygun Kablo Kesiti	FİYAT PRICE
YMK 01	Y Branşman Ek Muf Kalıbı No: 1	1,5-10	75,00 ₺
YMK 02	Y Branşman Ek Muf Kalıbı No: 2	10-25	626,00 ₺
YMK 03	Y Branşman Ek Muf Kalıbı No: 3	35-70	765,00 ₺
YMK 04	Y Branşman Ek Muf Kalıbı No: 4	95-120	950,00 ₺
YMK 05	Y Branşman Ek Muf Kalıbı No: 5	150-240	1.205,00 ₺
EMK 01	Şeffaf Düz Ek Muf Kalıbı No: 1	10-25	86,50 ₺
EMK 02	Şeffaf Düz Ek Muf Kalıbı No: 2	35-95	114,00 ₺
EMK 03	Şeffaf Düz Ek Muf Kalıbı No: 3	10-25	480,00 ₺
EMK 04	Şeffaf Düz Ek Muf Kalıbı No: 4	35-70	665,00 ₺
EMK 05	Şeffaf Düz Ek Muf Kalıbı No: 5	95-240	886,00 ₺
TMK 01	T Branşman Ek Muf Kalıbı No: 1	10-25	180,00 ₺
TMK 02	T Branşman Ek Muf Kalıbı No: 2	35-95	259,00 ₺
TMK 03	T Branşman Ek Muf Kalıbı No: 3	120-240	915,00 ₺

BUAT KAPAĞI
JUNCTION COVER

KOD CODE	GÖVDE ÇAPİ MAIN DIAMETER (cm)	TIRNAK UZUNLUĞU LOCK OF LENGTH (cm)	KUTU / ADET UNIT / BOX	FİYAT PRICE
BK 01	9,1	8,3	250	5,50 ₺

36 kV EKRANLI KABLO BAŞLIKLARI PLUG IN CABLE TERMINATION



KOD CODE	CİNSİ TYPE	KABLO KESİTİ CROSS SECTION (mm ²)	KABLO YALITKAN ÇAPI INSULATION DIAMETER OF CABLE (mm ²)	FİYAT PRICE
TLS36 35-70	L TIPI	35-70	26-29	
TLS36 95-150		95-150	30-34	
TLS36 185-240		185-240	35-40	
TLS36 400-500		400-500	41-46	
TTS36 35-70	T TIPI	35-70	26-29	
TTS36 95-150		95-150	30-34	
TTS36 185-240		185-240	35-40	
TTS36 400-500		400-500	41-46	

AG & OG YALITIM HALISI LV & MV INSULATION SHEET

KOD CODE	YALITIM DEĞERİ INSULATION RATE	FİYAT PRICE
TH06	1kV'a Kadar	
TH36	36kV'a Kadar	



OG YALITIM SEHPASI MV INSULATION STAND

KOD CODE	YALITIM DEĞERİ INSULATION RATE	FİYAT PRICE
TSS36	36kV'a Kadar	



OG YALITIM ELDİVENİ VE STANKA MV INSULATION GLOVE AND MANEUVER BAR

KOD CODE	CİNSİ TYPE	FİYAT PRICE
TE36 (Eldiven)	36kV'a Kadar	
TST36 (Stanka)	36kV'a Kadar	



DİKKAT ÖLÜM TEHLİKESİ UYARI LEVHASI WARNING SIGN

KOD CODE	CİNSİ TYPE	FİYAT PRICE
TLE36	Sarı Paslanmaz Metal Levha	



HAVAI HAT KİLİTLEME EL ALETİ OVERHEAD-LINE HAND TOOL

KOD CODE	CİNSİ TYPE	FİYAT PRICE
THK 2R	2 açılı, paslanmaz, kilitleme	1.345,00 ₺



OG KABLO SOYMA EL ALETİ MV CABLE STRIPPING HAND TOOL

KOD CODE	CİNSİ TYPE	FİYAT PRICE
TSEL01	Yarı İletken ve İzolasyon Soyma El Aleti	





Elektriksel Yalıtımda Yerli Çözümler



TAMER



tamflex



ProSil

TAMER ELEKTRİK
İMALAT SANAYİ TİCARET LİMİTED ŞİRKETİ

ŞUBE / BRANCH

Anafartalar Mah. Kuruçeşme Sk. No: 3/A-B Ulus - ANKARA / TÜRKİYE

Tel : +90 312 324 12 71 - 311 94 71 - 310 18 05

Fax : +90 312 324 45 74

ŞUBE / BRANCH

Elektrokent İş Merkezi 1467. Cad. No: 2/29

İvedik O.S.B. / Ostim / ANKARA / TÜRKİYE

Tel : +90 312 395 17 20 - 21 - 24

Fax : +90 312 395 17 23

FABRİKA/MERKEZ / FACTORY / HEAD OFFICE

İstanbul Yolu 26. Km. Saray Mah. Saray Cad. No: 4

Kazan - ANKARA / TÜRKİYE

Tel : +90 312 815 44 74 - 815 45 52

Fax : +90 312 815 45 53

www.tamerelektrik.com.tr

tamer@tamerelektrik.com.tr - info@tamerelektrik.com.tr



ISO-EN
9001

ISO-EN
14001

ISO
45001

RoHS

CE

